

ACERAS Y CONTENES
SECTOR GREGORIO LUPERON 2DA ETAPA

DETALLE DE ACERA - CONTEN -

CANTIDAD DE TRABAJO
178 MT DE ACERA
178MT DE CONTEN

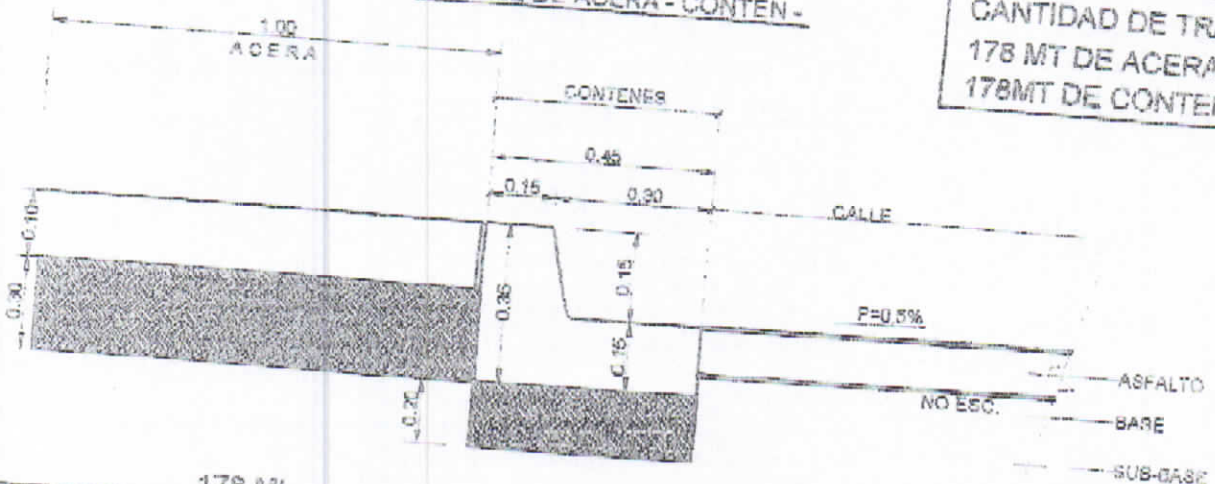

DETALLE ACERAS
NO ESC.

ACERAS Y CONTENES
SECTOR VISTA NUEVA

DETALLE DE ACERA - CONTEN -

CANTIDAD DE TRABAJO
220 MT DE ACERA
220 MT DE CONTEN

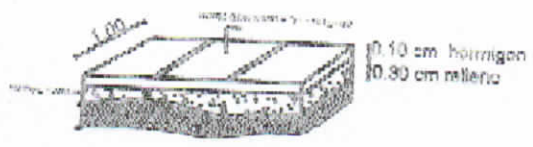
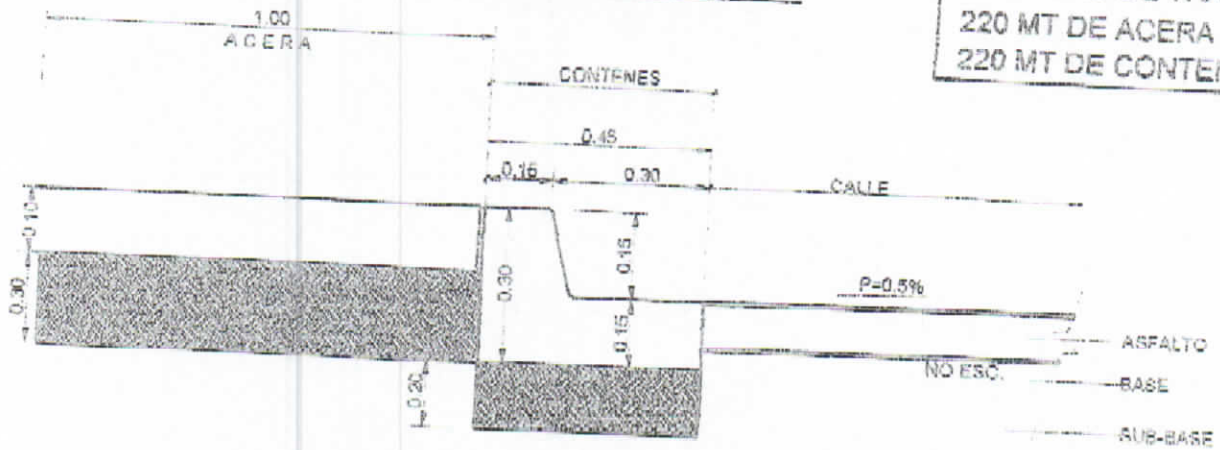

DETALLE ACERAS
NO ESC.

ACERAS Y CONTENES
URBANIZACION CAMPO FERNANDEZ

DETALLE DE ACERA - CONTEN -

CANTIDAD DE TRABAJO
500 MT DE ACERA
500 MT DE CONTEN

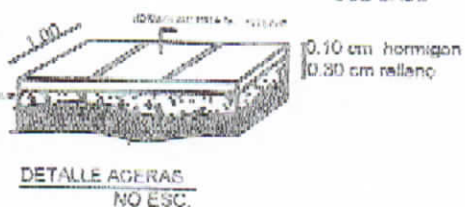
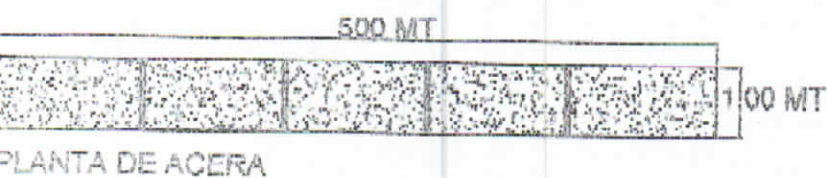
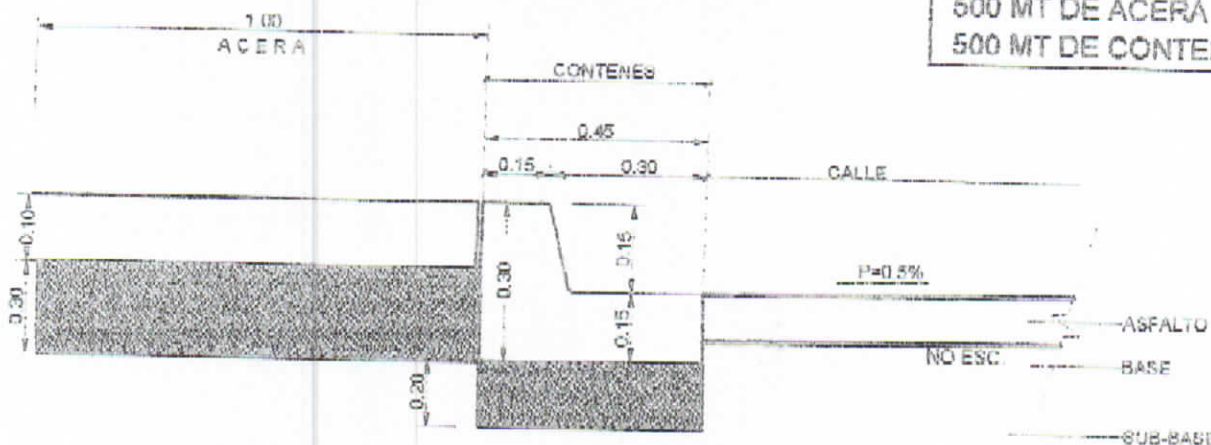

ACERAS Y CONTENES
SECTOR SALVADOR THEN Y THEN

DETALLE DE ACERA - CONTEN -

CANTIDAD DE TRABAJO
430.40 MT DE ACERA
430.40 MT DE CONTEN

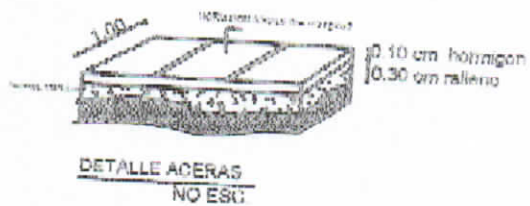
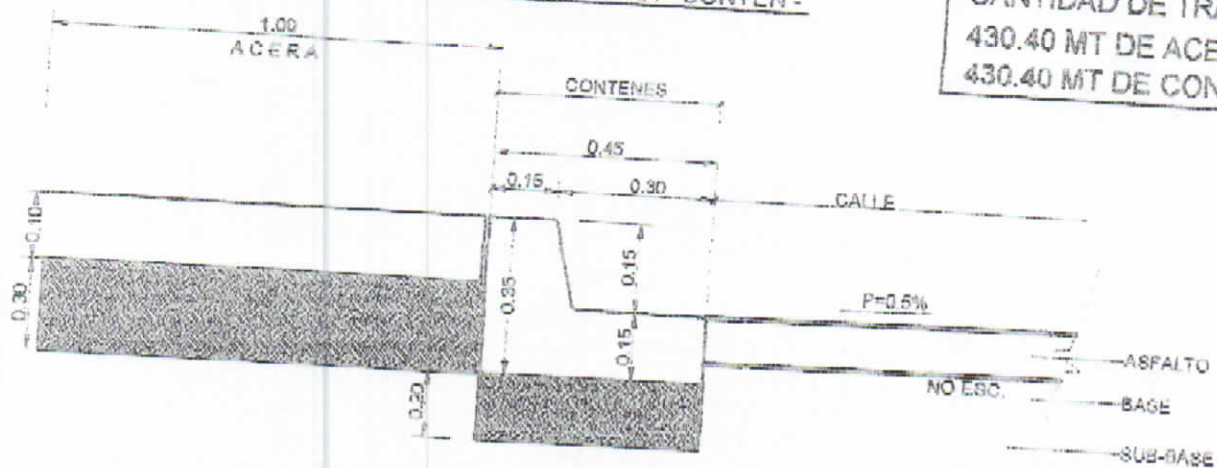

GRADAS - SECTOR GREGORIO
LUPERON - VISTA DEL VALLE

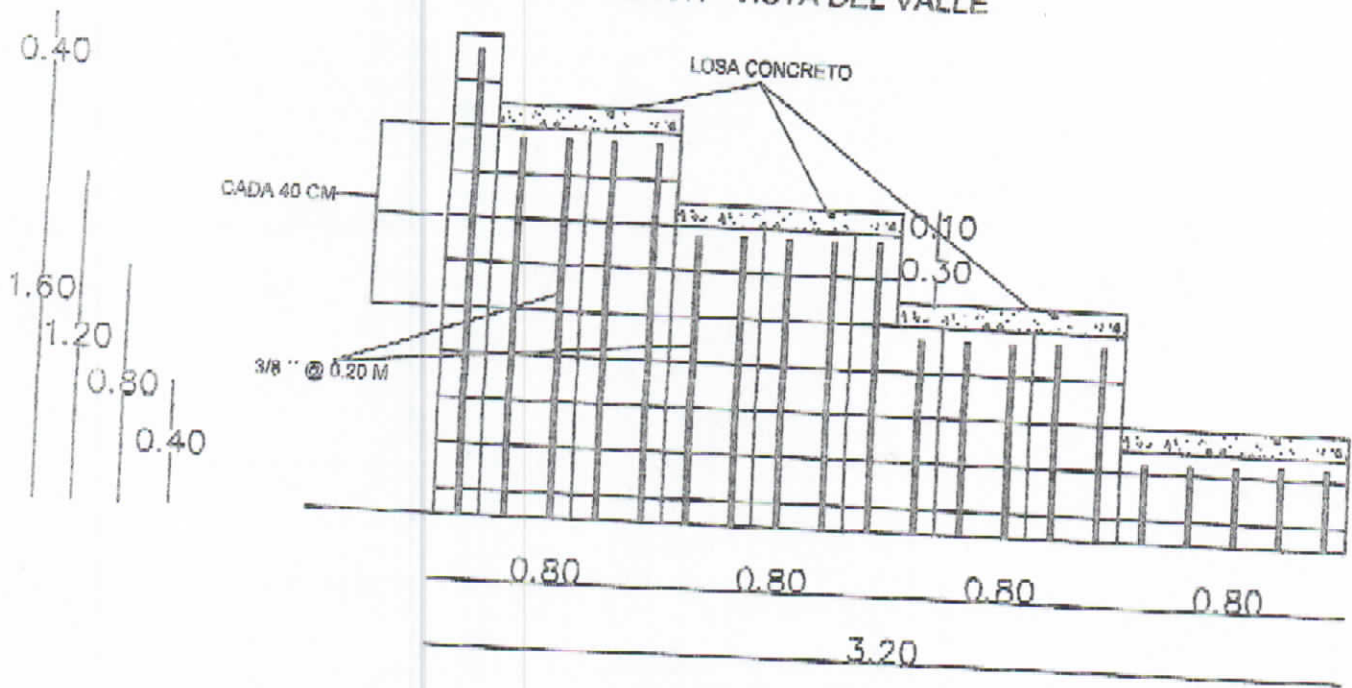

 SECCION

ZAPATAS DE MUROS (Elevación)
Sección transversal

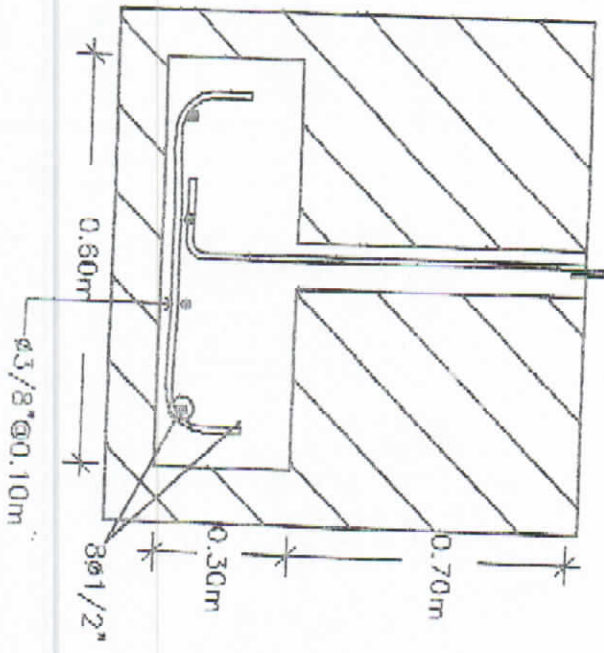

ZAPATAS DE MUROS (Planta)
Sección transversal

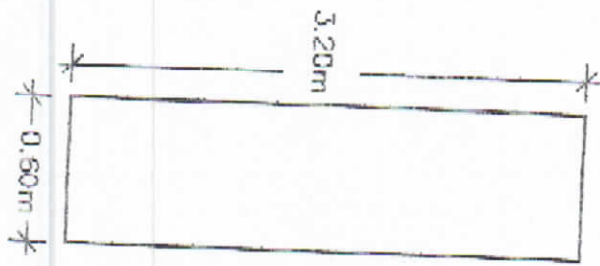

DETALLE PERIMETRAL DE GRADAS
NO ESC.

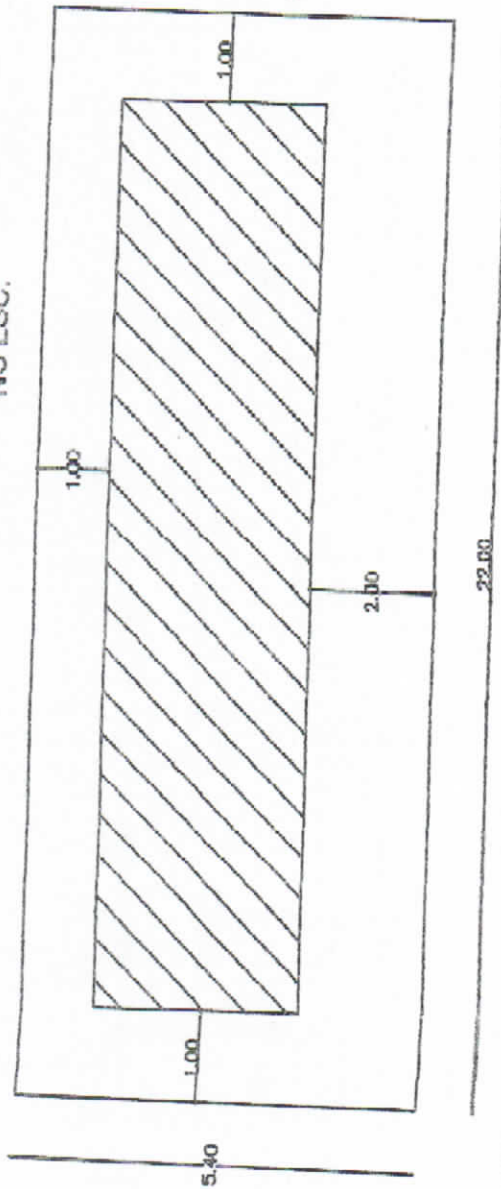

DETALLE ACERAS
NO ESC.

GRADAS - LAS GUAZUMAS (COTE)

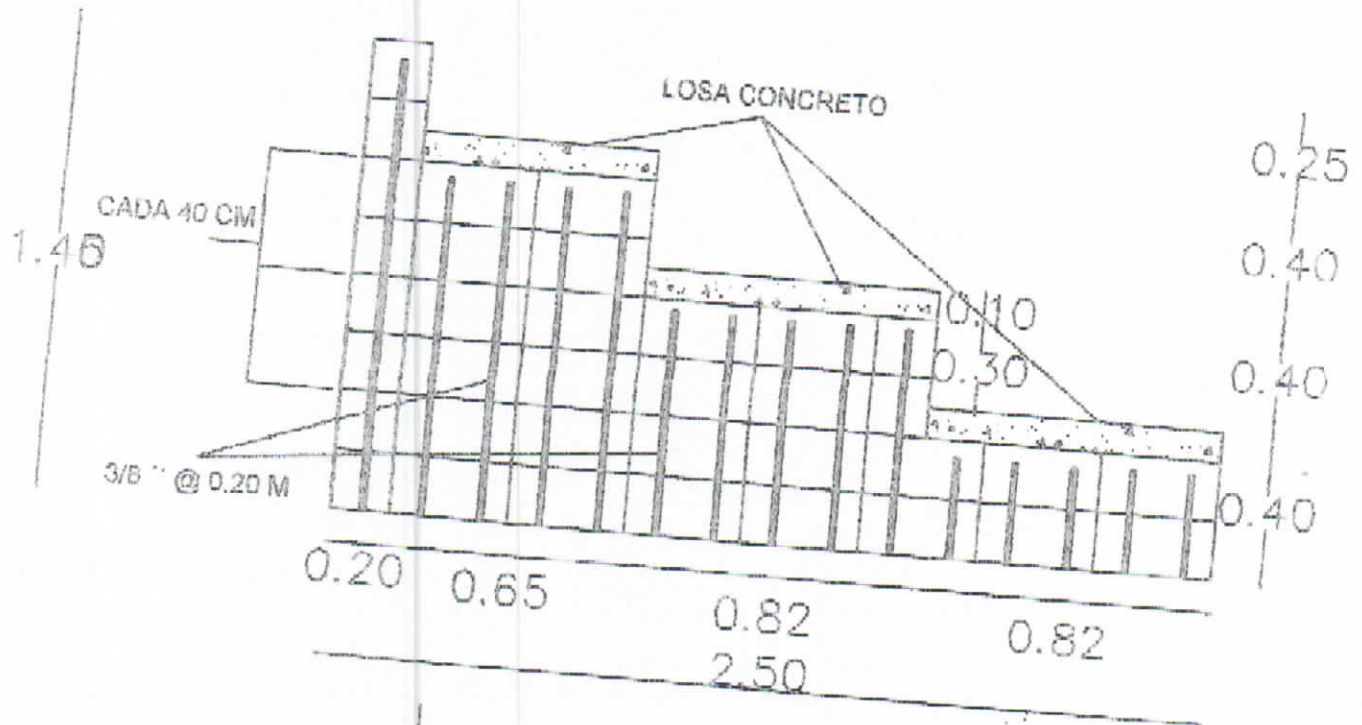

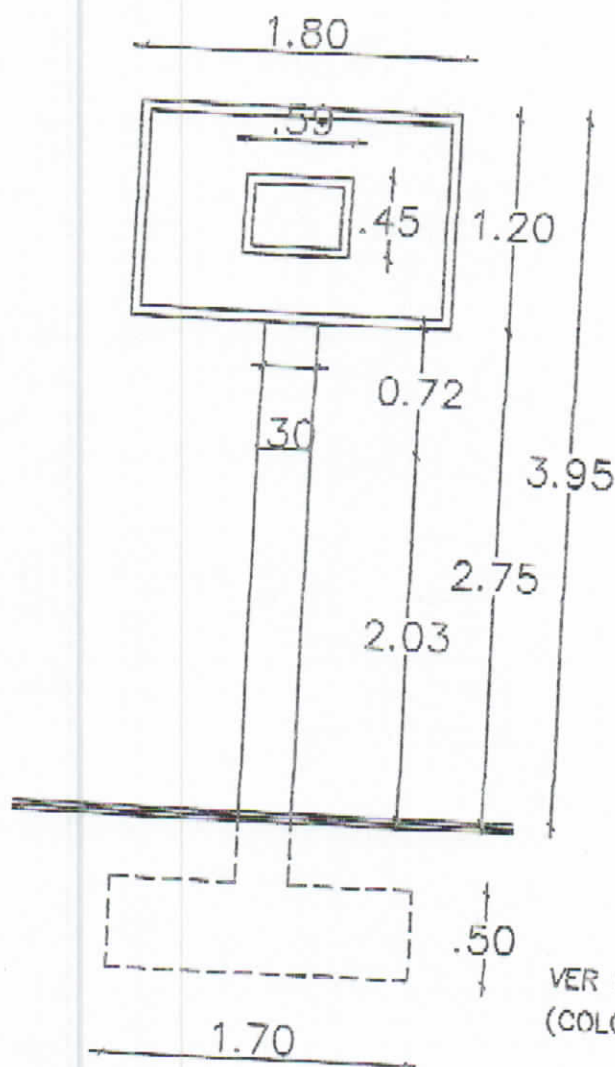

VER DETALLE "A"
(COLOCACION DE TORNILLO)

3

ELEVACION FRONTAL TABLERO

NO ESCALA

SECCION 1-1' : seccion transversal columna

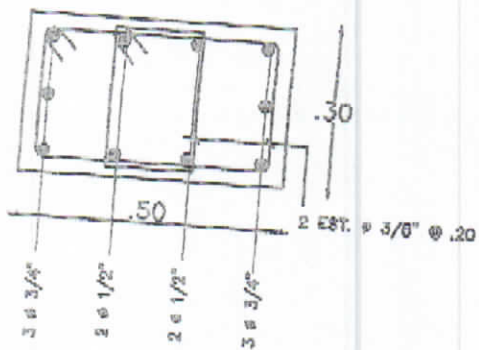

SECCION 2-2' : seccion transversal viga

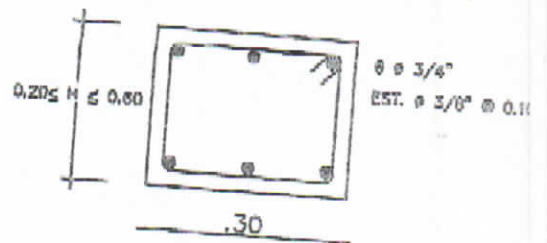

SECCION 3-3' : seccion transversal viga

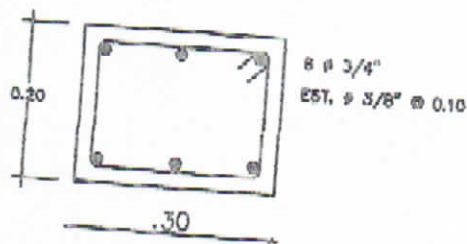

7 SECCIONES SOPORTE DE TABLERO

NO ESCALA

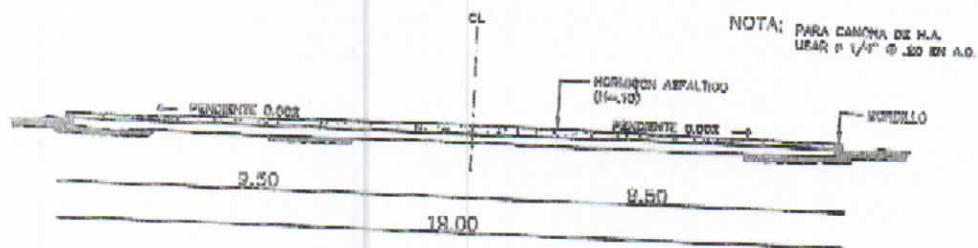

4 **DETALLE BORDILLO**

1 = 100 M

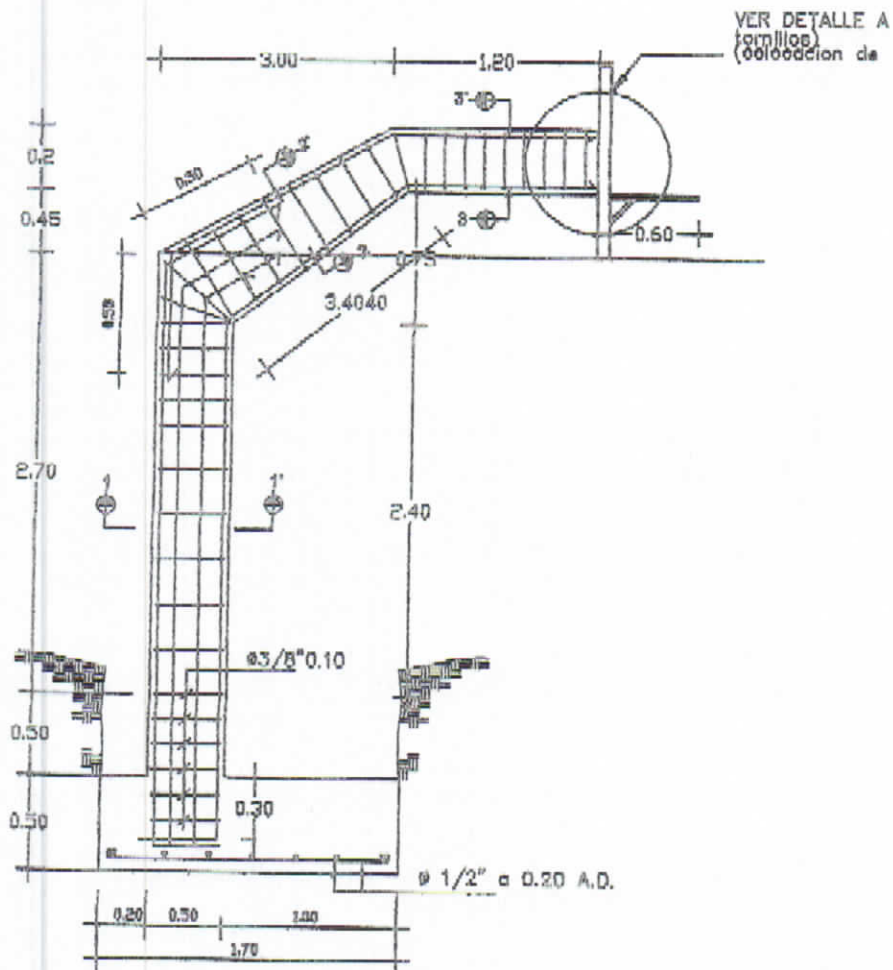

5 SECCION LONGITUDINAL SOPORTE TABLERO

NO ESCALA

SECCION
SOPORTE TABLERO

NO ESCALA

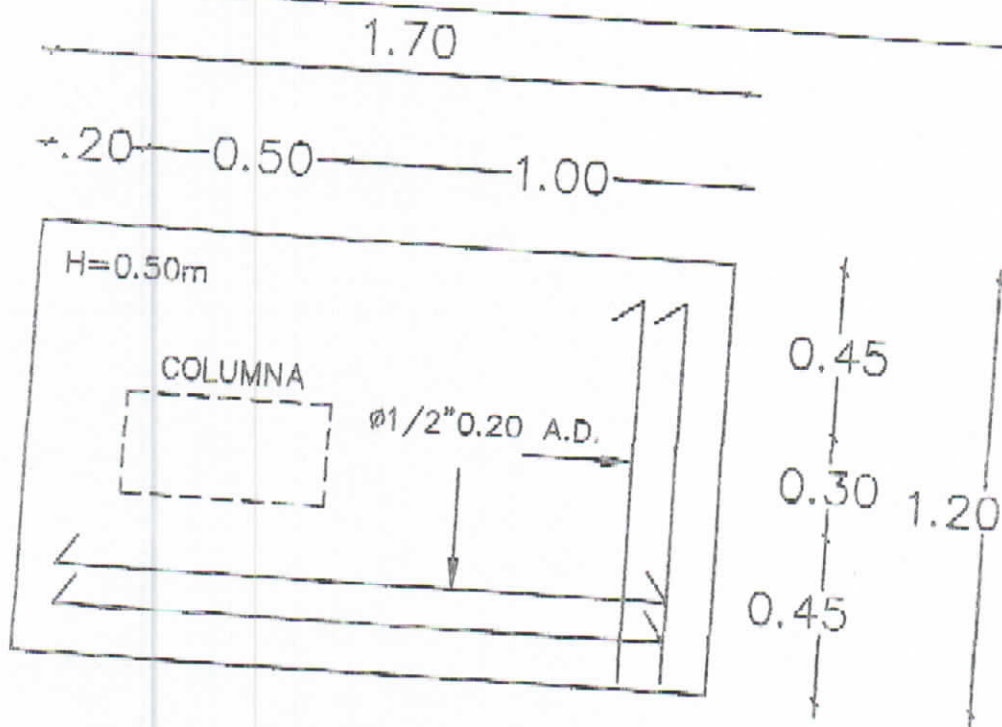

6

PLANTA DE ZAPATA

NO ESCALA

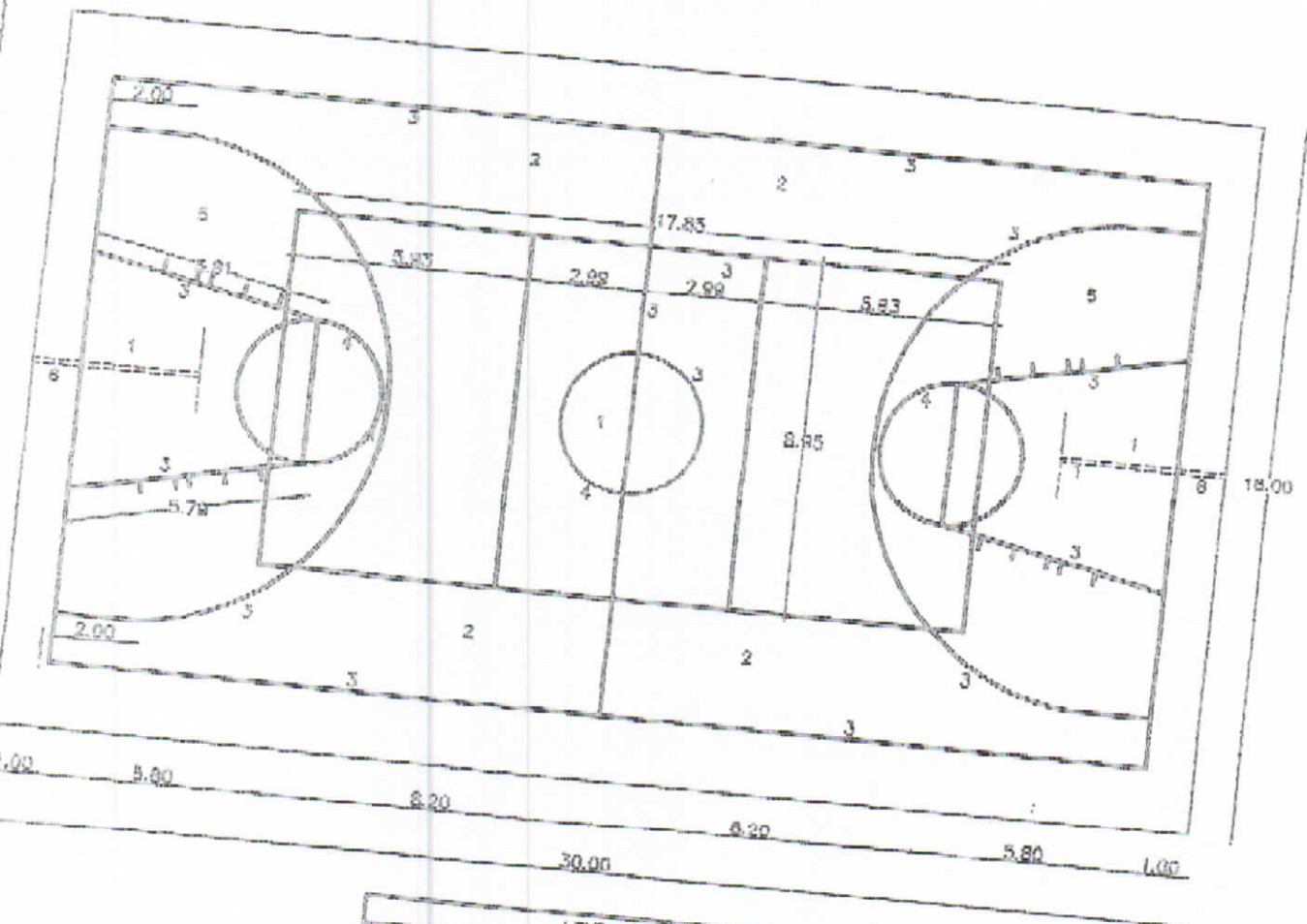

LEYENDA	
1. COLOR ROJO	4. COLOR AZUL
2. COLOR VERDE	5. COLOR NARANJA
3. COLOR BLANCO (REDONDO)	6. COLOR PAREDES BLANCAS

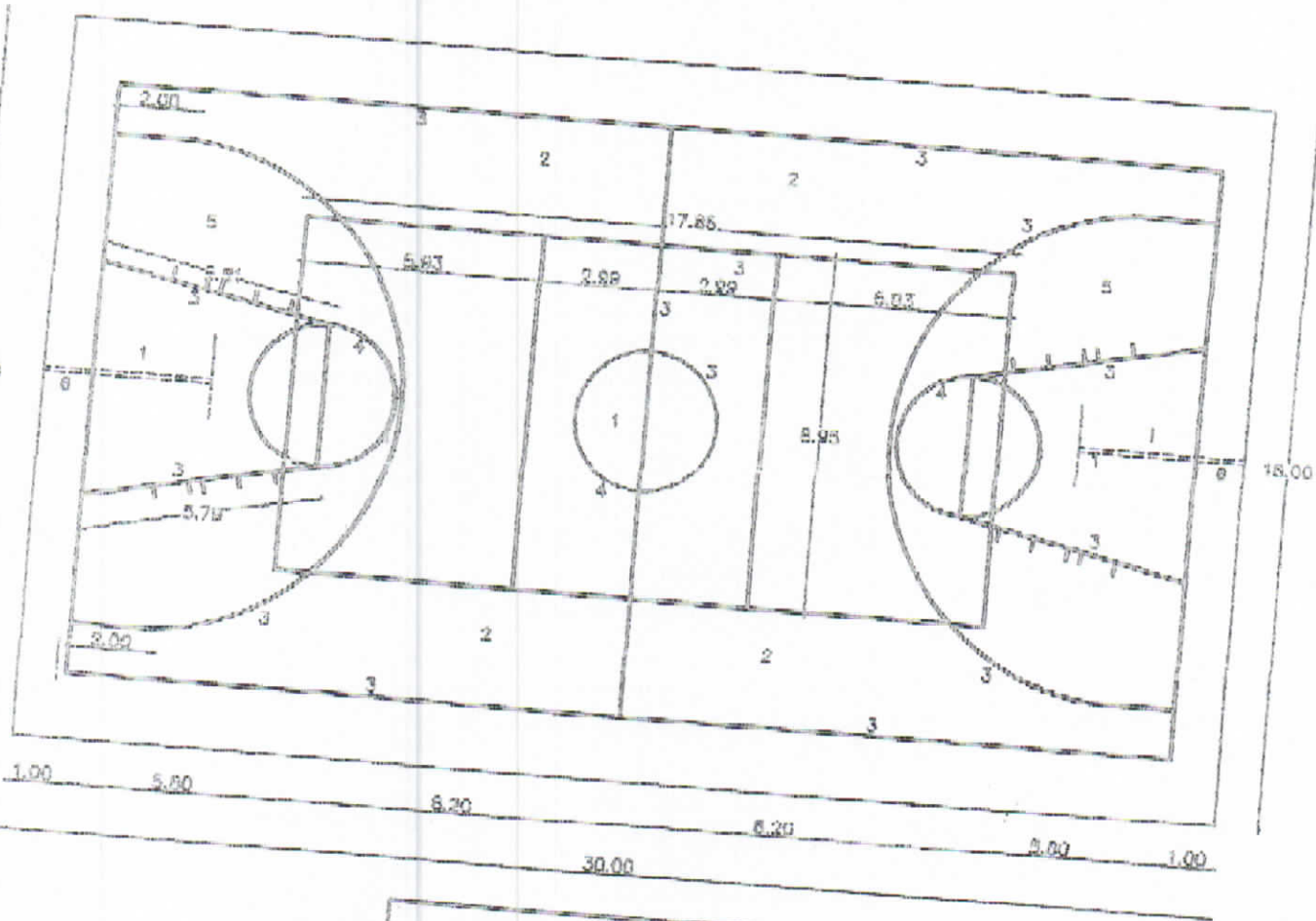

LEYENDA	
1. COLOR ROJO	A. COLOR AZUL
2. COLOR VERDE	B. COLOR NARANJA
3. COLOR BLANCO (NEGR)	C. COLOR PUEBLO MANT.

ZAPATAS DE MUROS (Elevación)

Sección transversal

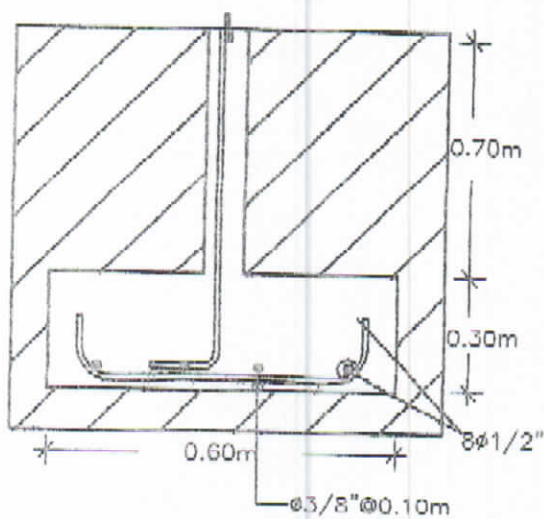

ZAPATAS DE MUROS (Planta)

Sección transversal

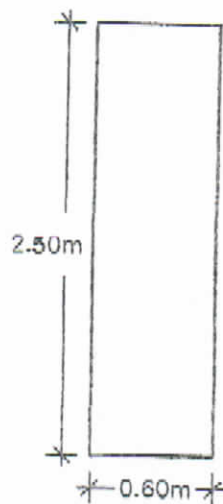

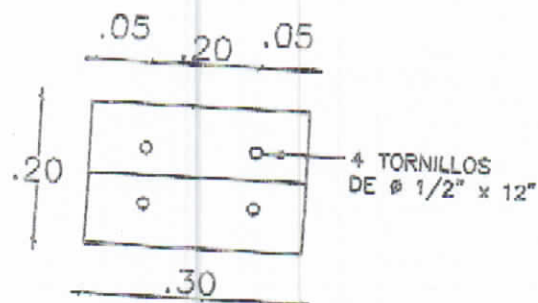

ELEVACION

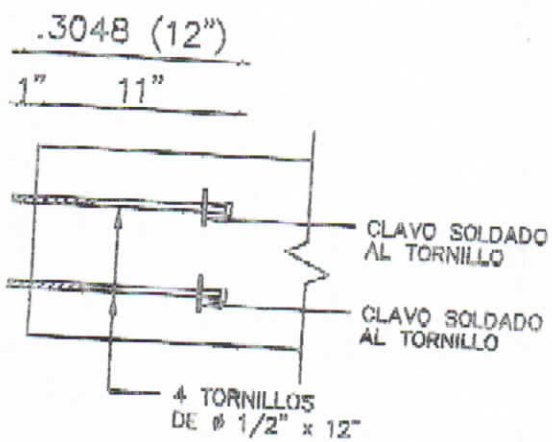

SECCION

8 **DETALLE COLOCACION DE TORNILLO**

NO ESCALA

JAVIELA

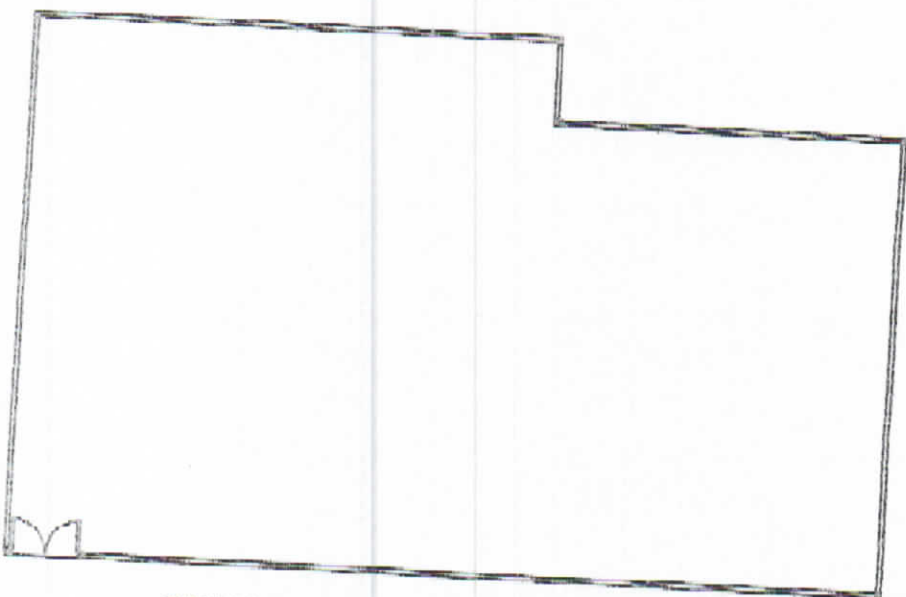

DETALLE DE COLUMNA

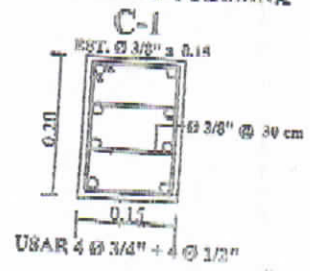

Z 1

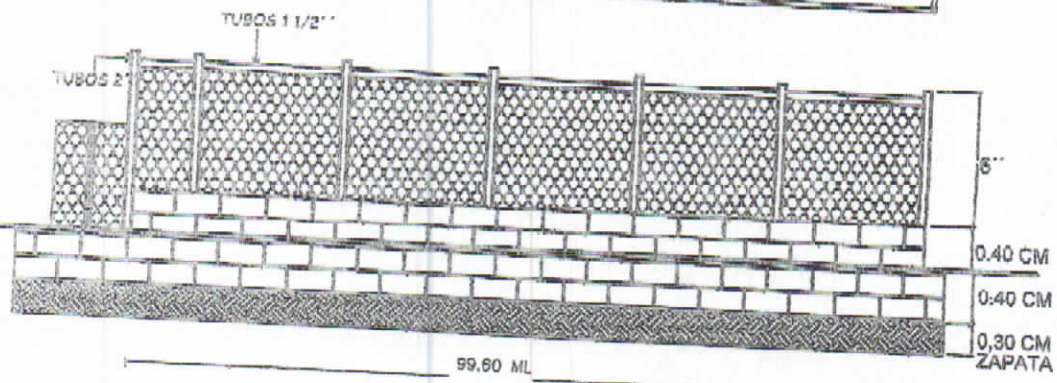
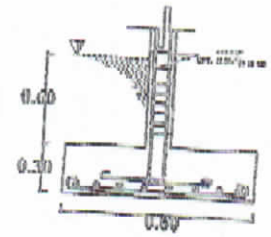

59.60 ML
MALLA CICLONICA 6"

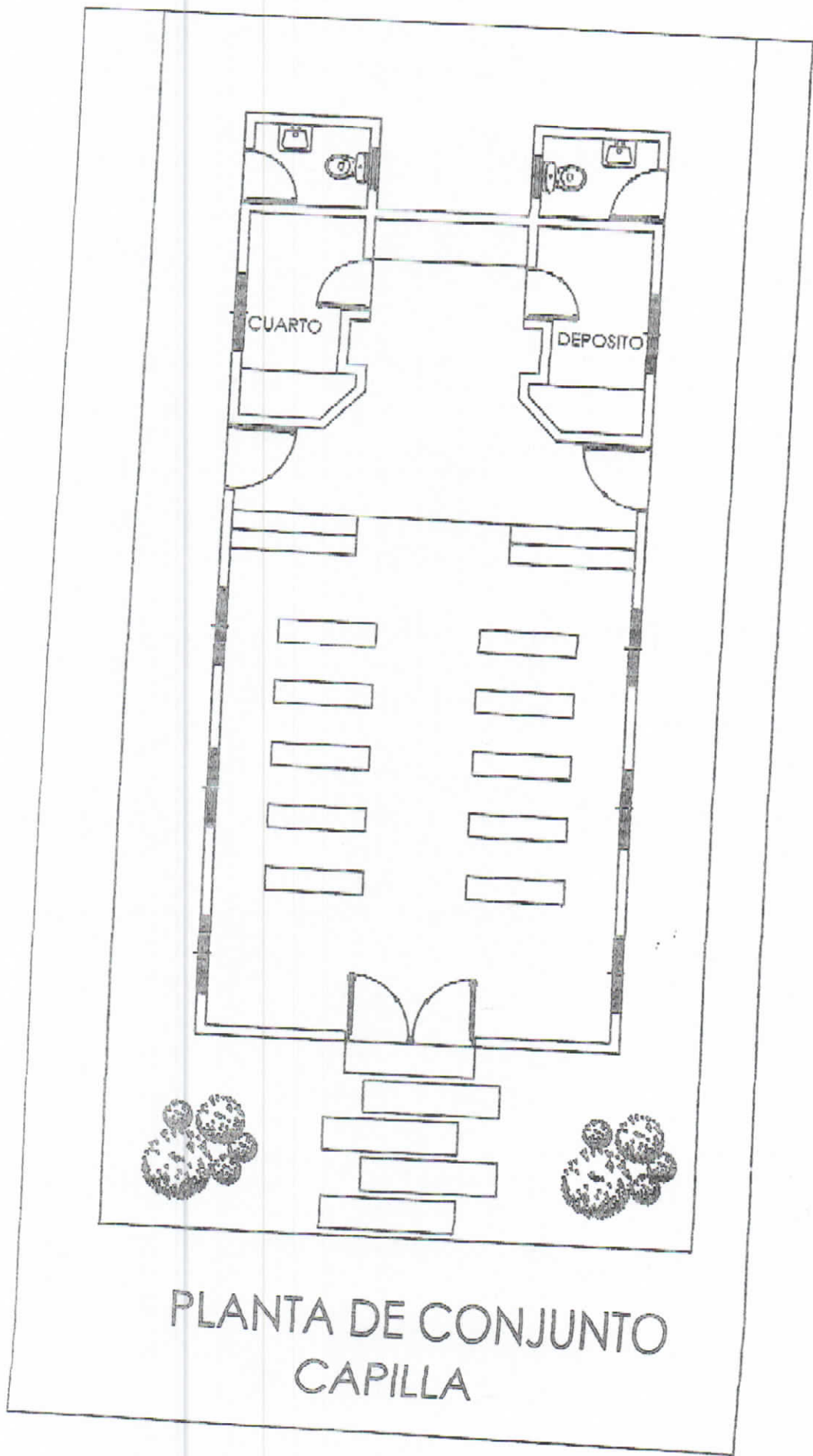

PLANTA DE CONJUNTO
CAPILLA

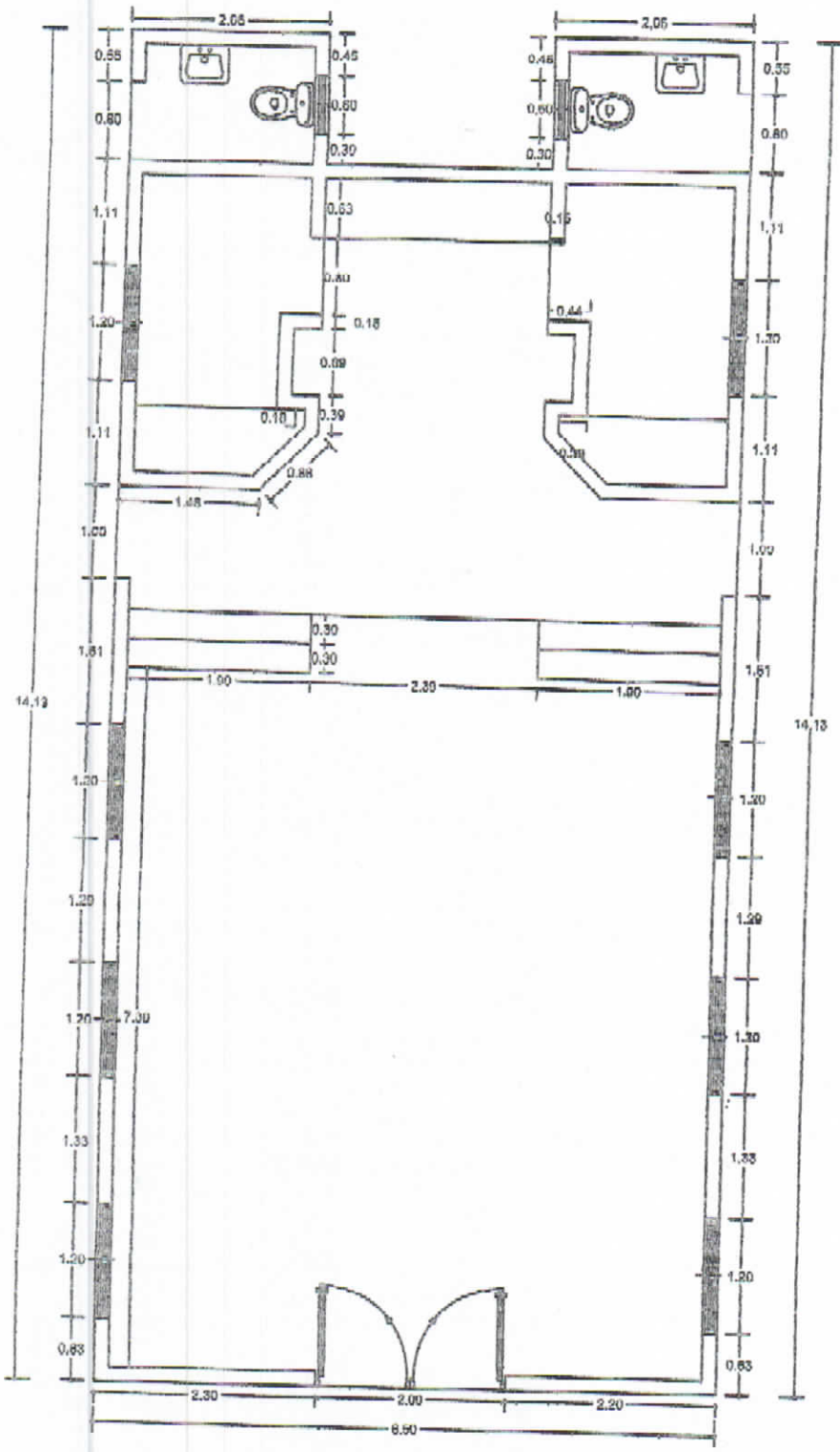

PLANTA DIMENSIONADA
CAPILLA

● PARQUE CAMINO AL MEDIO

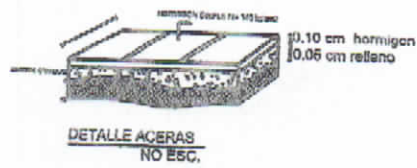
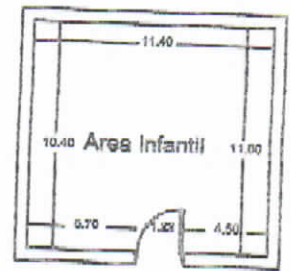
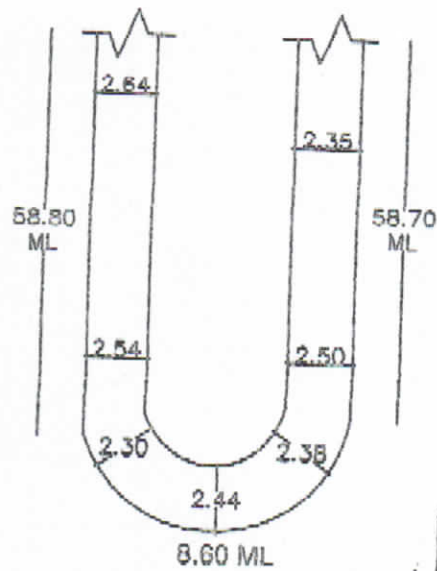
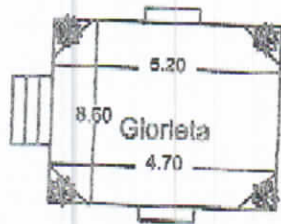
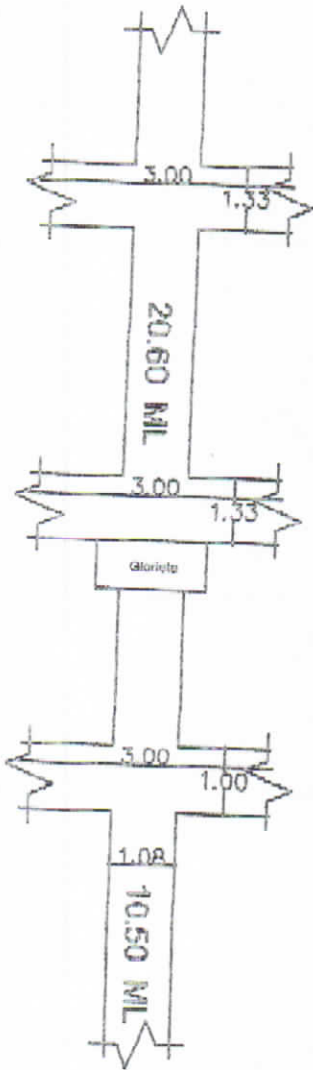

ENCACHE SECTOR MONSEÑOR MOYA

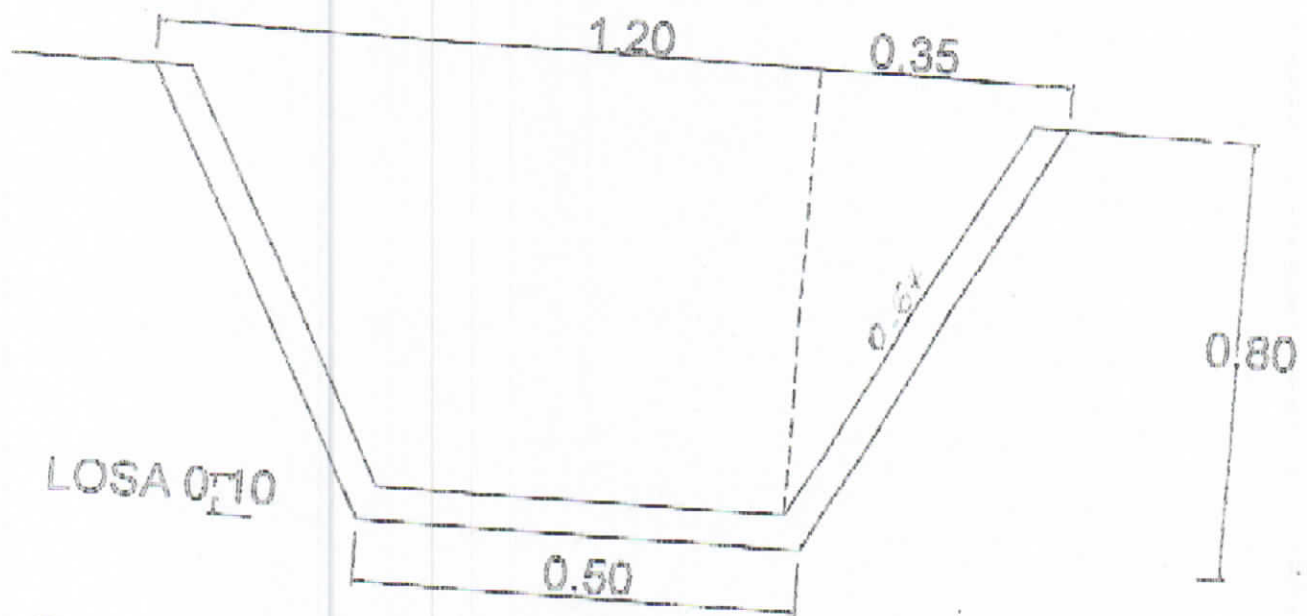

LOSA 0.10

ENCANQUE = 230 ML

TELFORD = 0.20 COMPACTADO

CASA DE ALTO LOS BEJUCOS

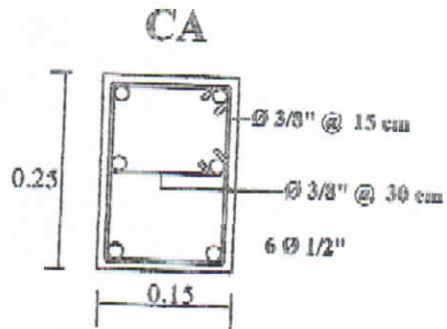
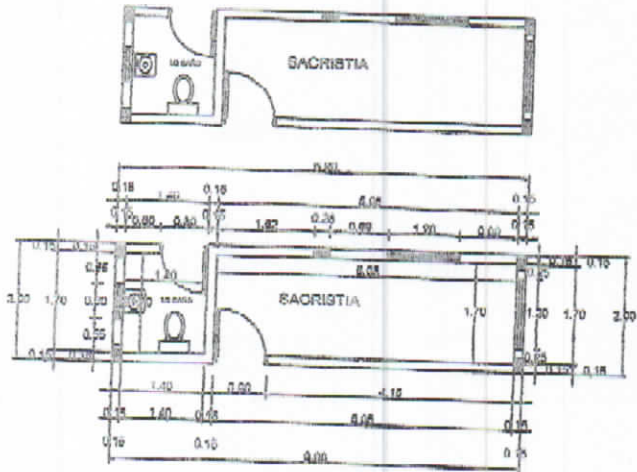

CASA DE ALTO - ACERA
LOS BEJUCOS

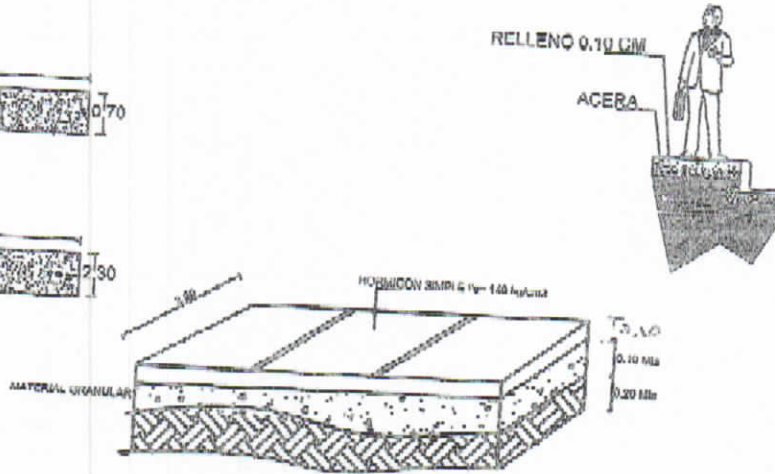

DETALLE ACERAS
NO ESC.

**ACERAS Y CONTENES
SECTOR OLIMPIA**

DETALLE DE ACERA - CONTEN -

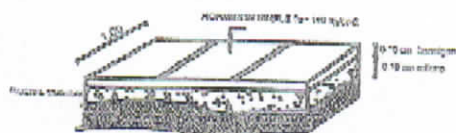
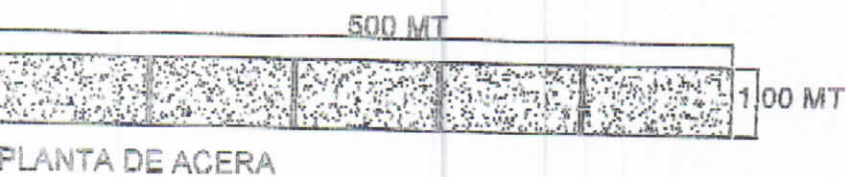
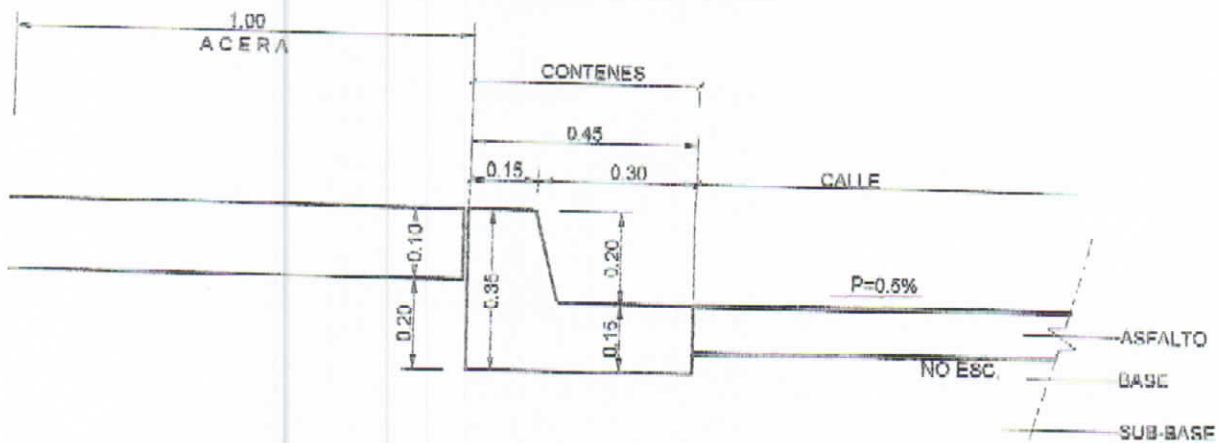

DETALLE ACERAS
NO ESC.

PERFILES DE LAMPARAS

NOTA:
PERFIL 3'' * 3''
ALTURA DE 14''
TUBOS GALVANIZADO HG

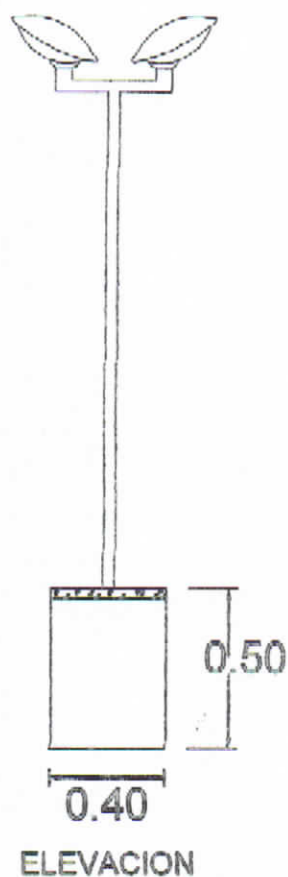
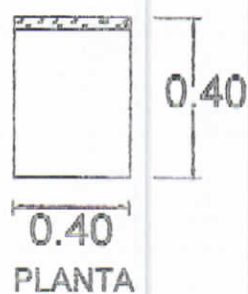

LAMPARAS LED DE 2 o 3 FOCOS.

DETALLE DE MUROS CONTENCION SECTOR DE CRISTO REY

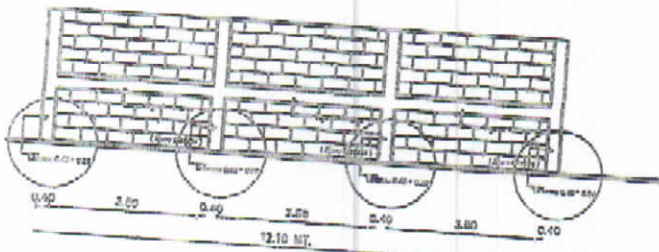

ELEVACION FRONTAL

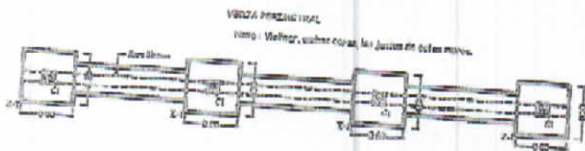

PLANTA DE FUNDACIONES

Z. 1

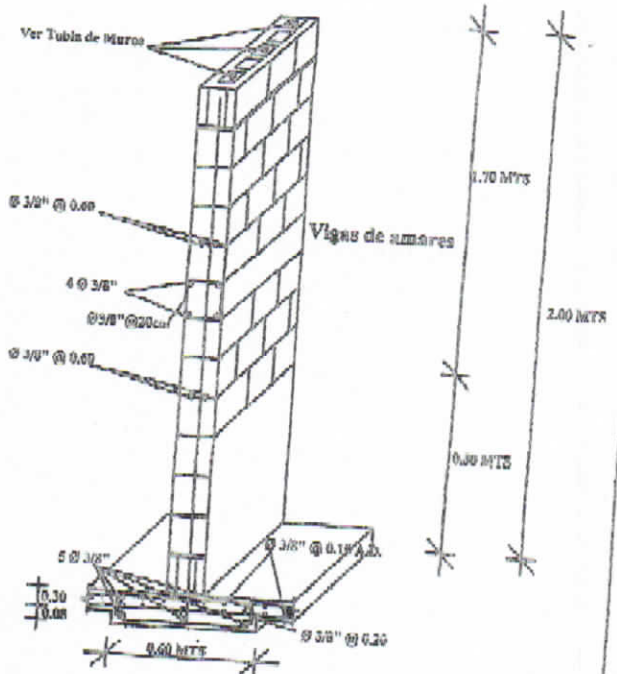
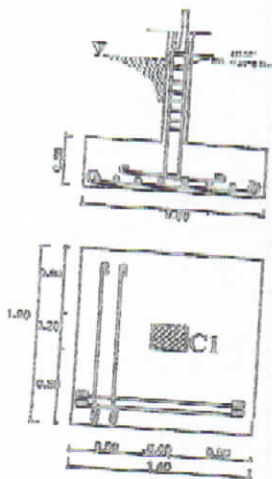

ACERA DE CLUB EN EL SECTOR DE CRISTO REY

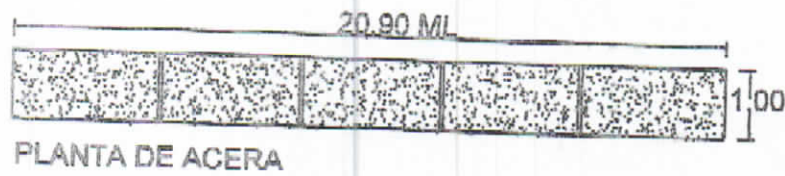

RELLENO 0.10 CM

ACERA

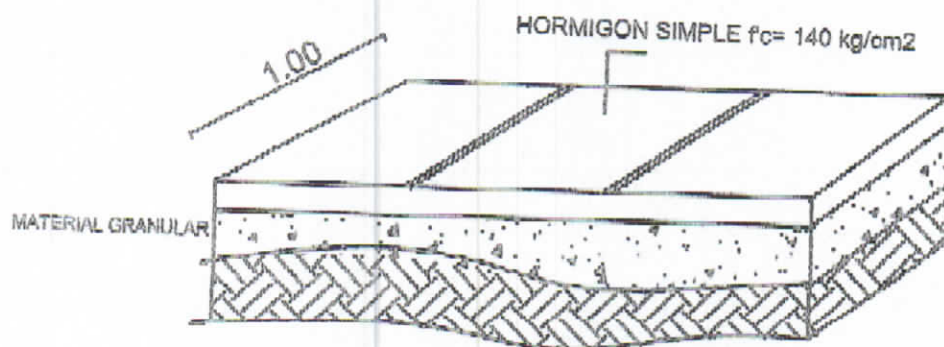
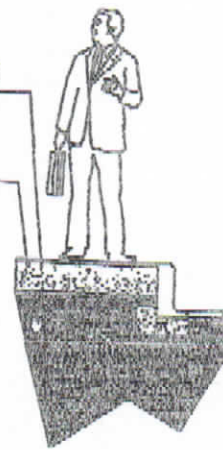

0.10 cm hormigon
0.10 cm relleno

DETALLE ACERAS
NO ESC.

PLAY BALBY

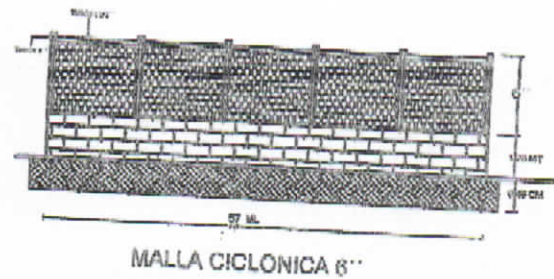
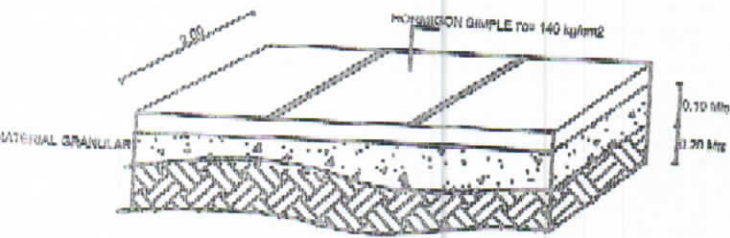
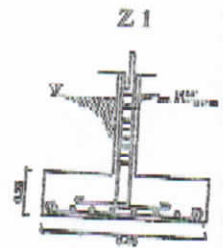
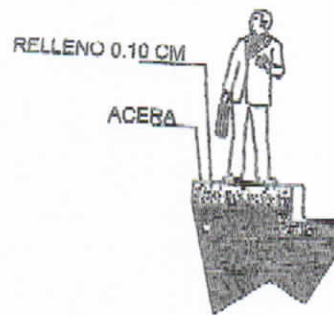

DETALLE ACERAS
NO ESC.

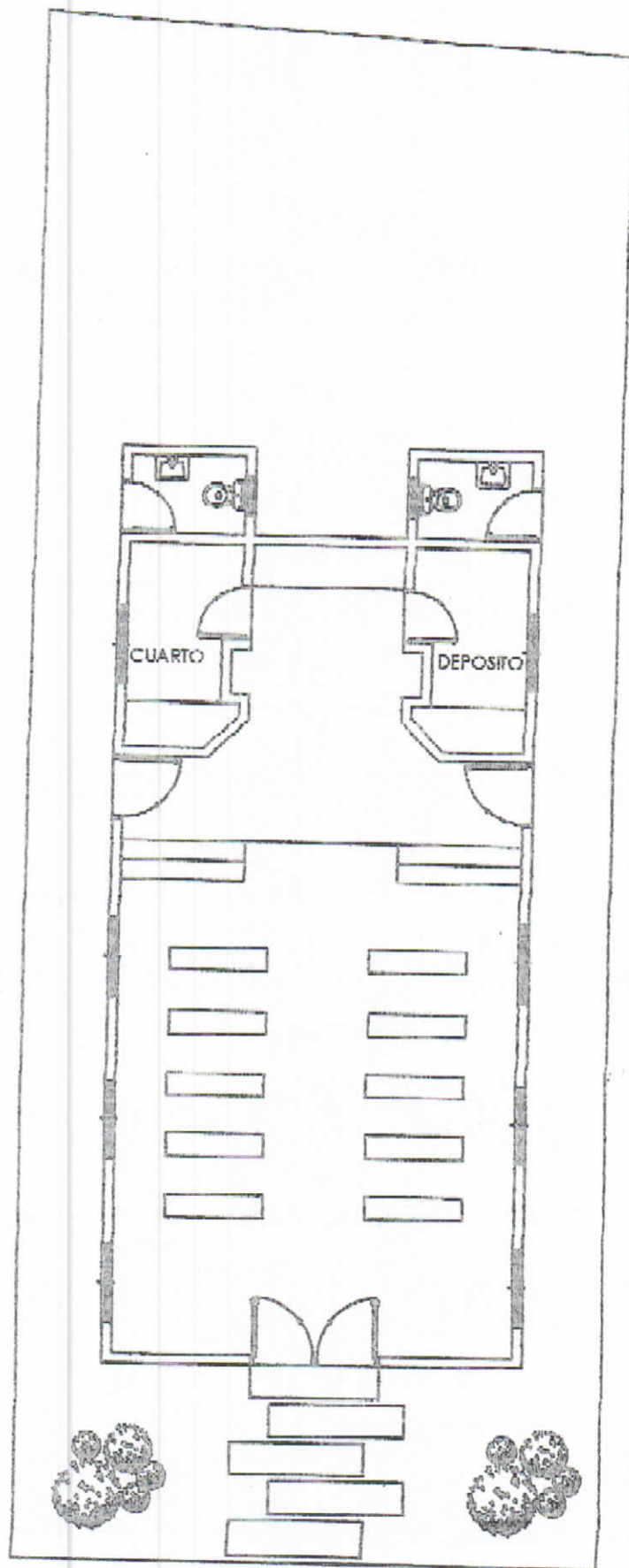

PLANTA DE CONJUNTO

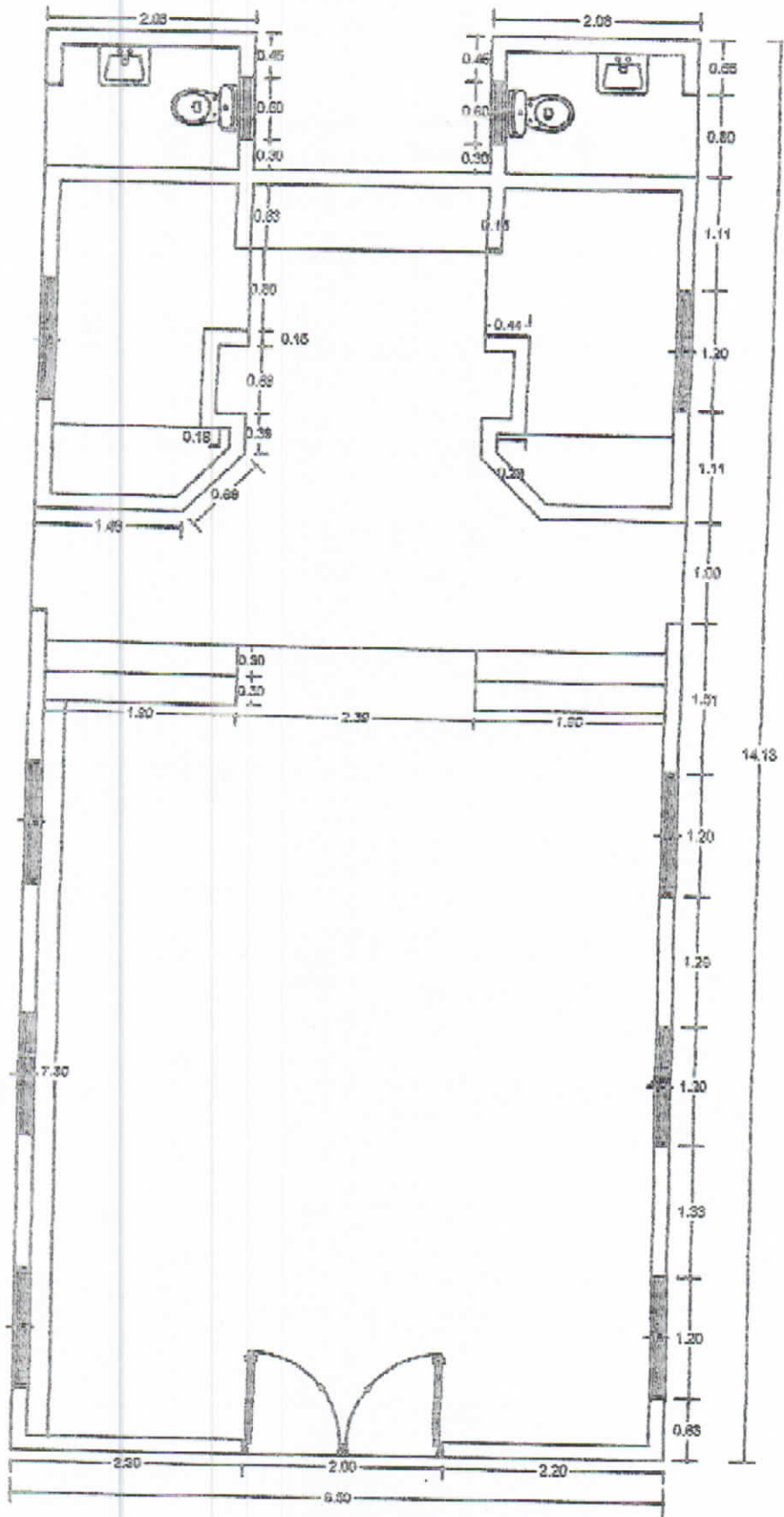

PLANTA DIMENSIONADA



88.64 MTS2

BADEN
GREGORIO LUPERON

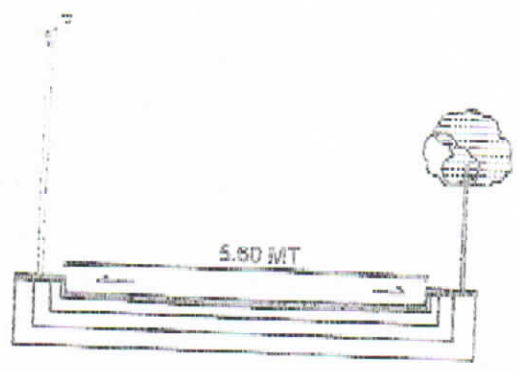
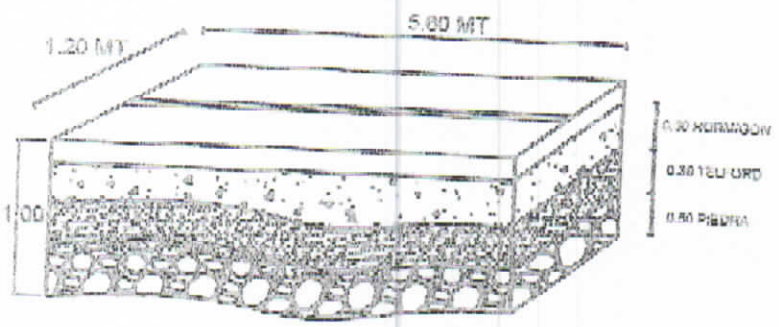

ENCEMENTADO GREGORIO LUPERON

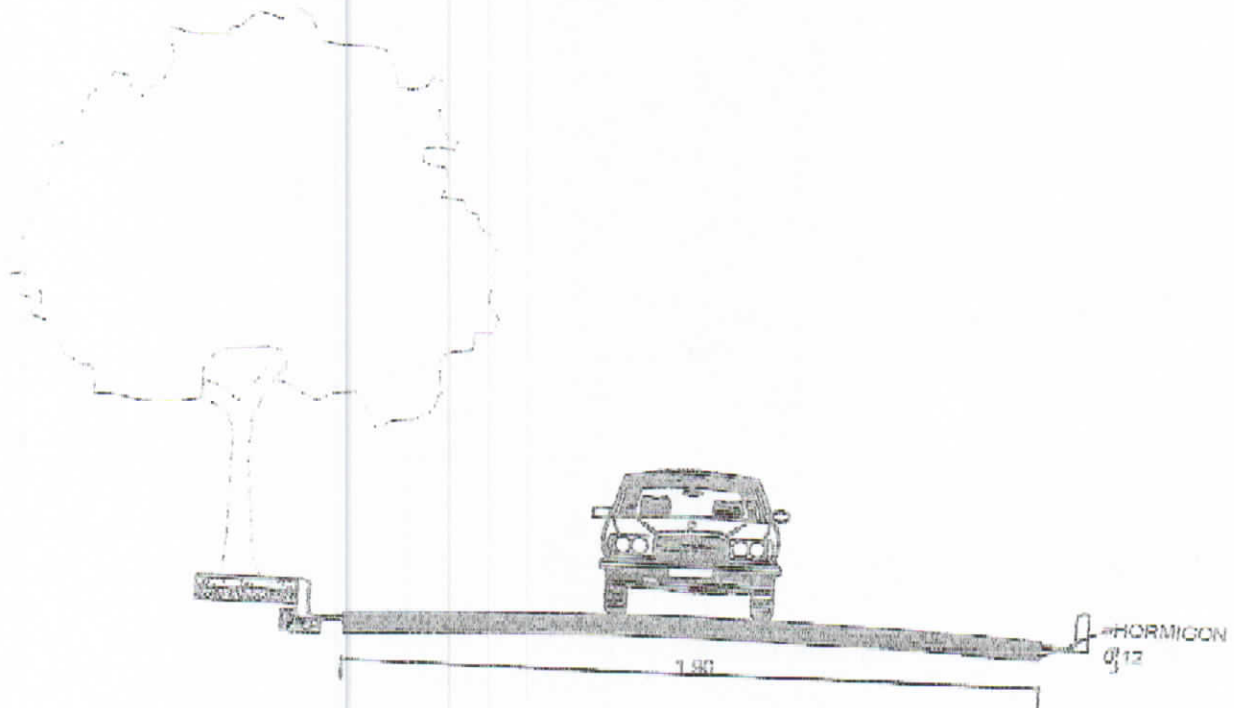

PLANTA ENCEMENTADO

NOTA: MALLA 20X20 E=12 CM

ENCEMENTADO GREGORIO LUPERON

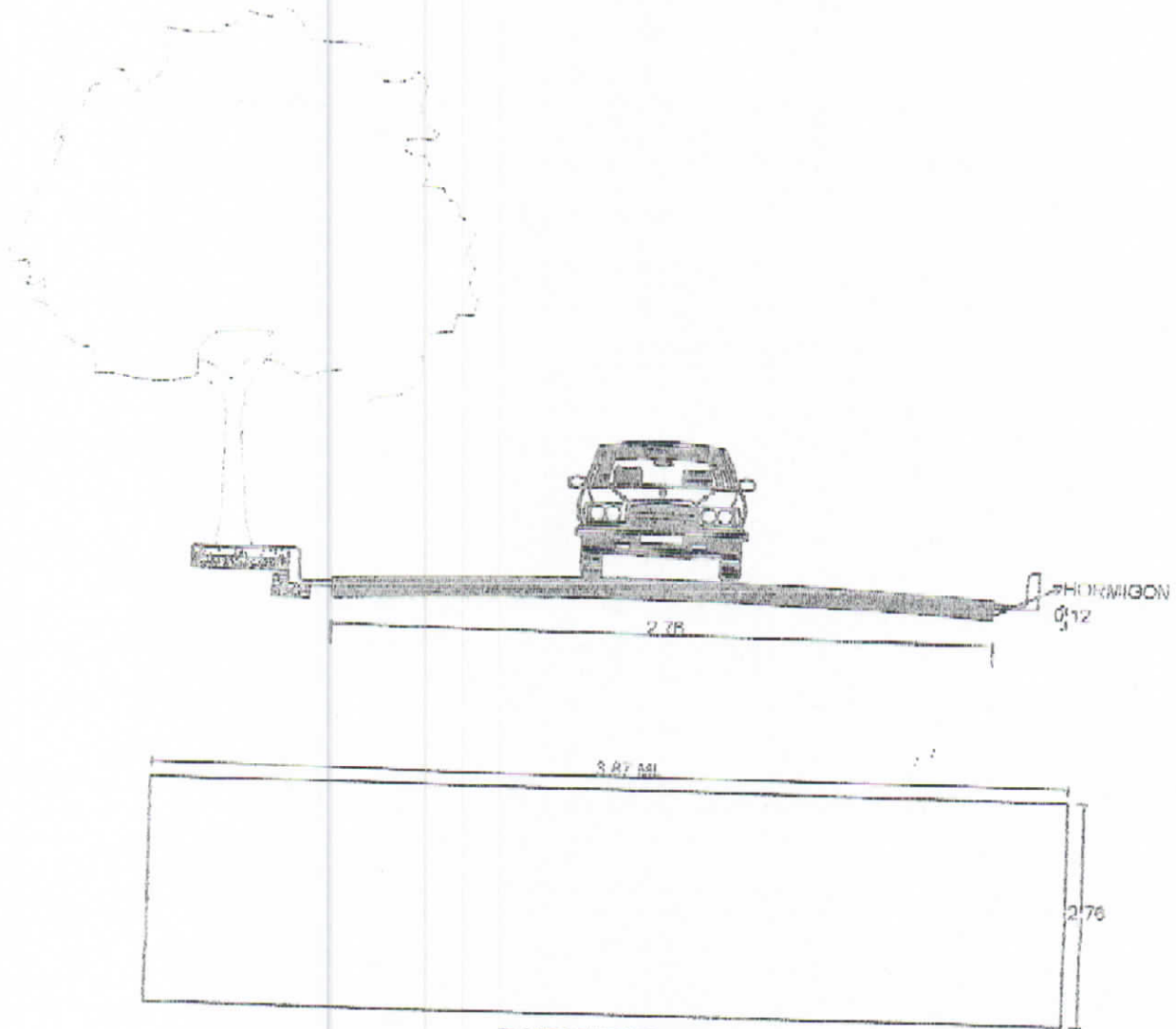

PLANTA ENCEMENTADO

NOTA: MALLA 20X20 E=12 CM

ENCEMENTADO GREGORIO LUPERON

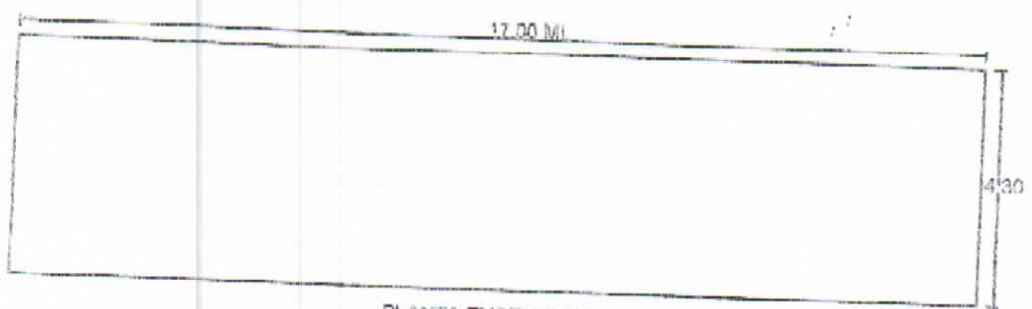
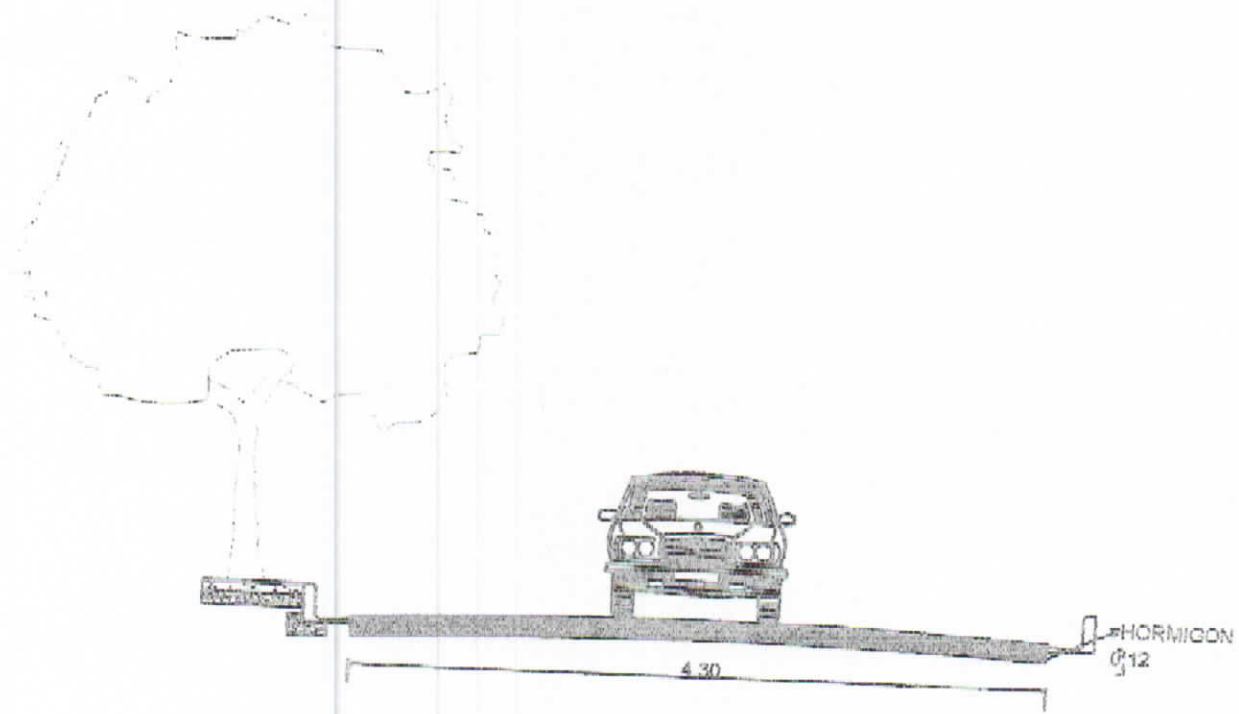

PLANTA ENCEMENTADO

NOTA: MALLA 20X20 E=12 CM

ENCEMENTADO GREGORIO LUPERON

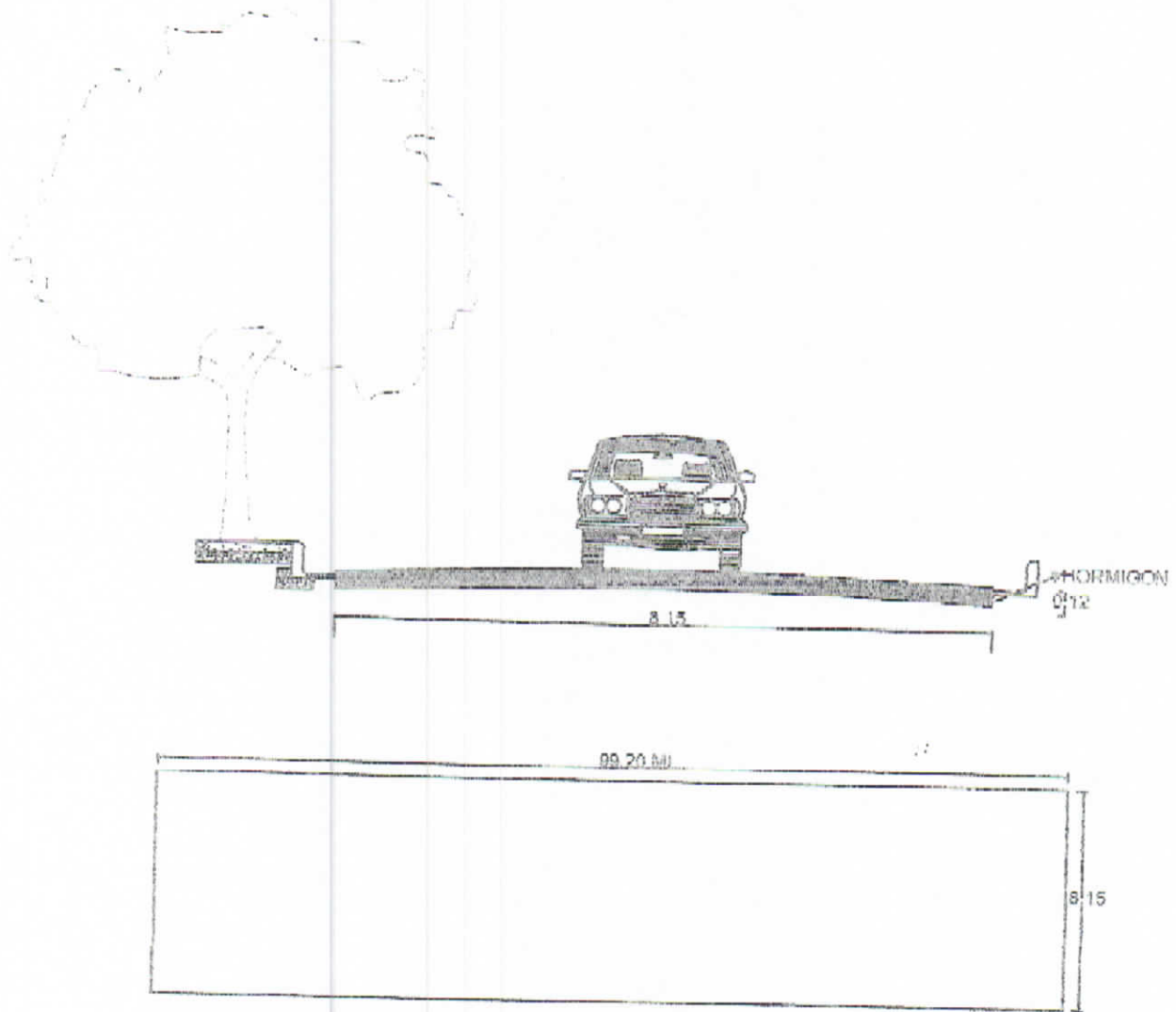

PLANTA ENCEMENTADO

NOTA: MALLA 20X20 E=12 CM

ENCEMENTADO GREGORIO LUPERON

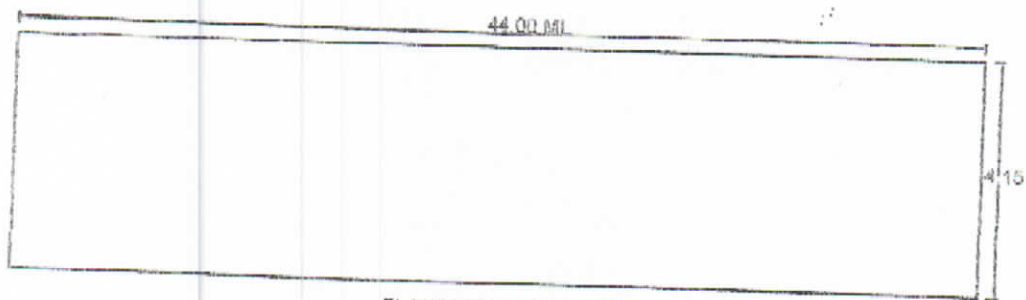
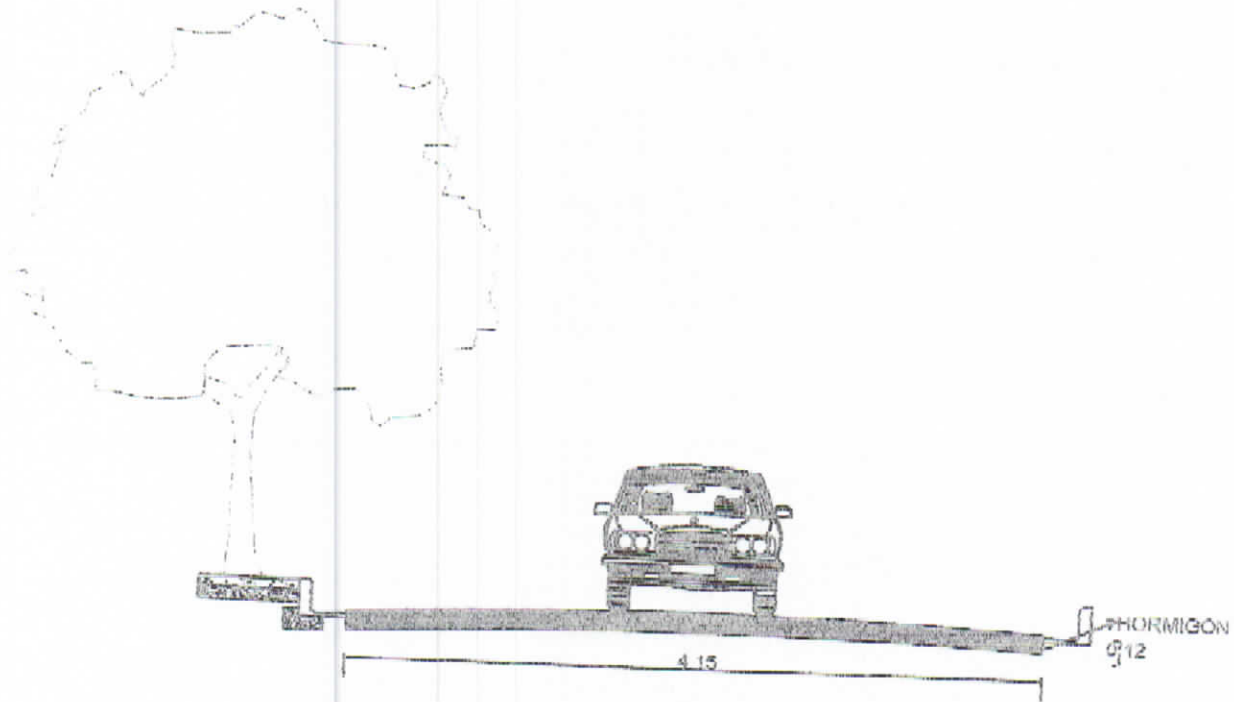

PLANTA ENCEMENTADO

NOTA: MALLA 20X20 E=12 CM

ENCEMENTADO GREGORIO LUPERON

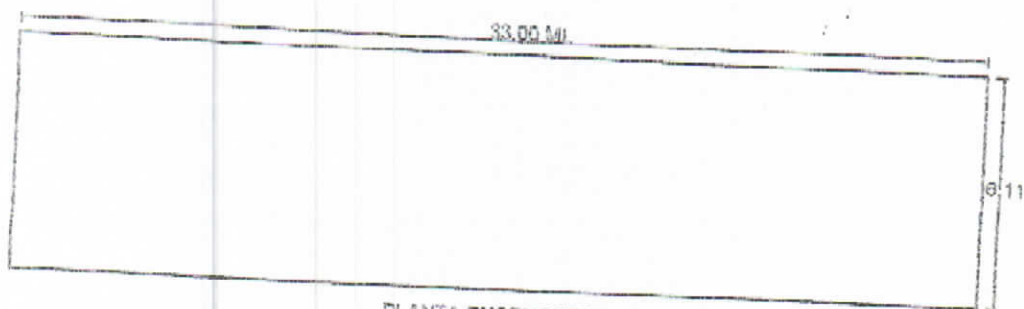
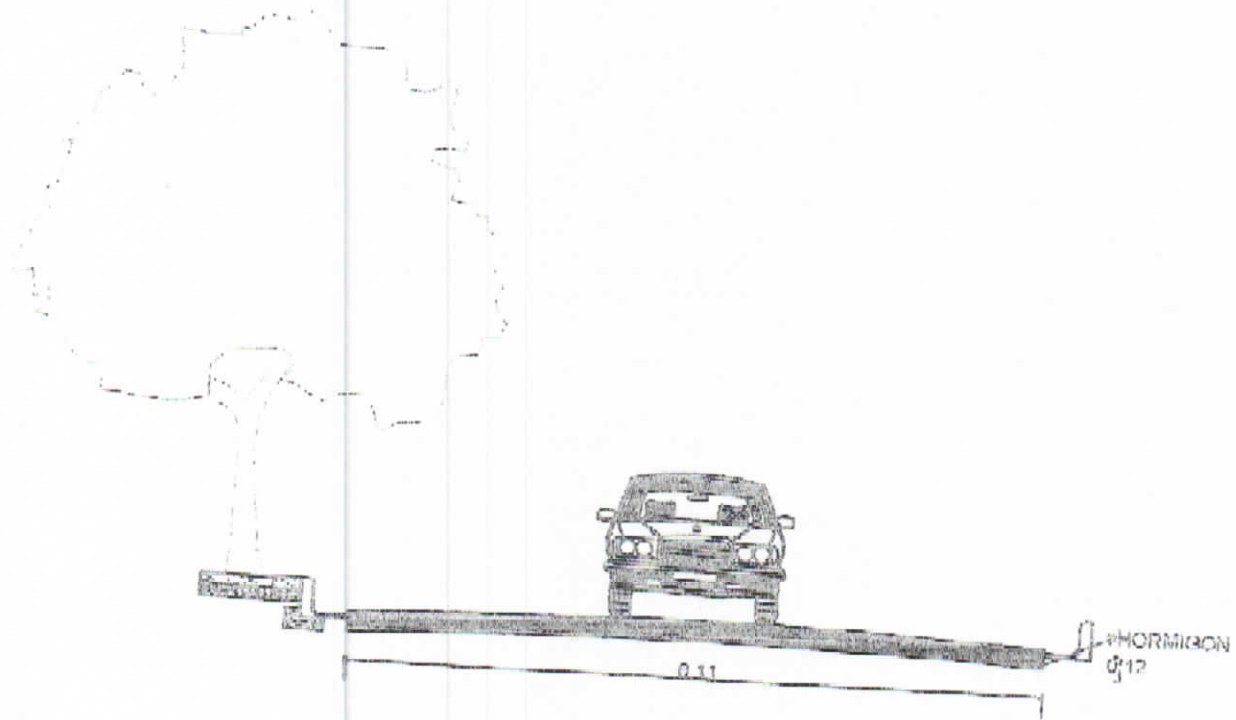

PLANTA ENCEMENTADO

NOTA: MALLA 20X20 E=12 CM

ENCEMENTADO GREGORIO LUPERON

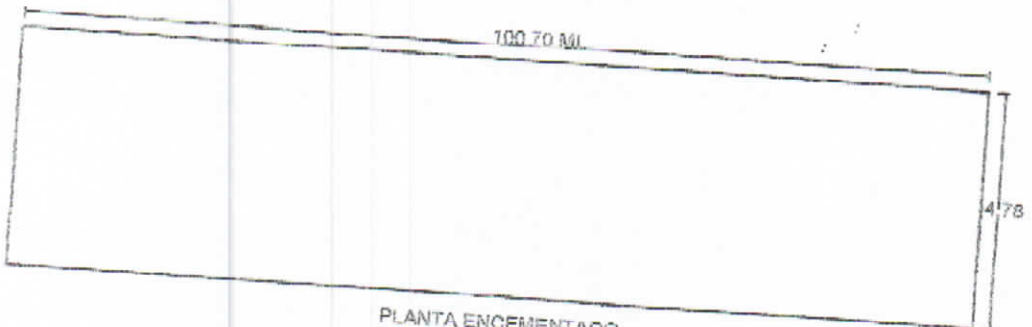
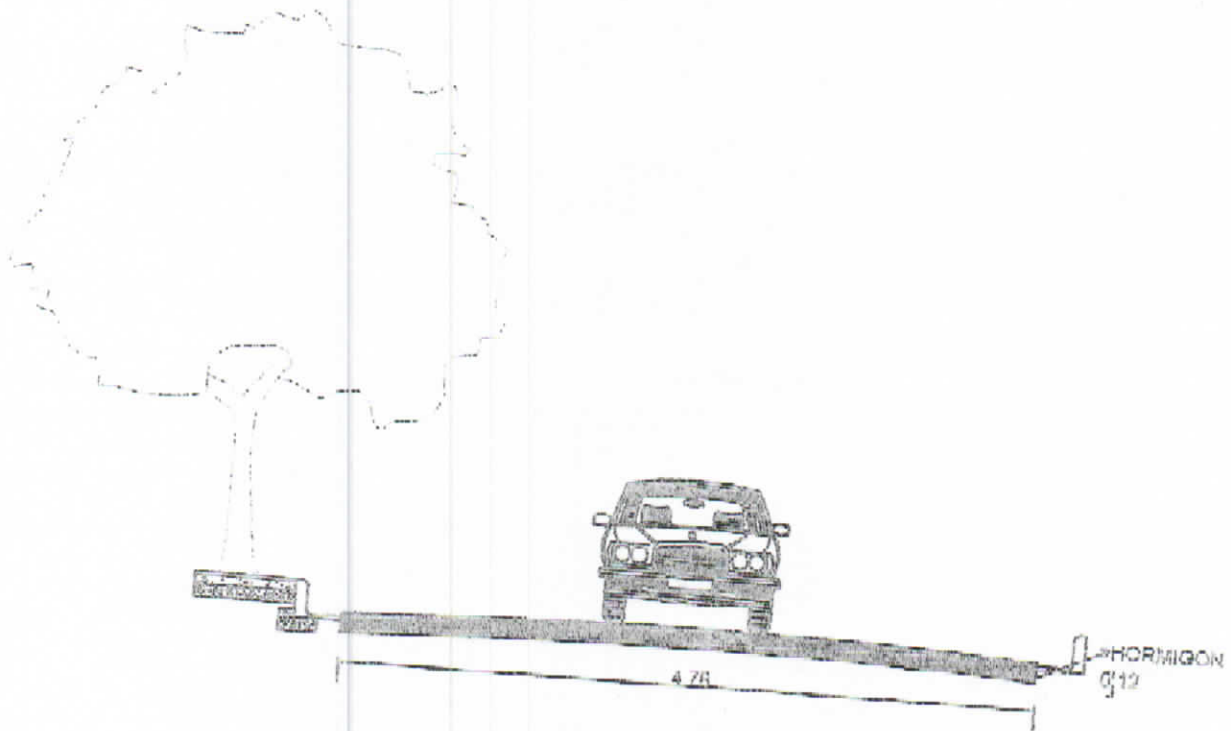

PLANTA ENCEMENTADO

NOTA: MALLA 20X20 E=12 CM

ENCEMENTADO GREGORIO LUPERON

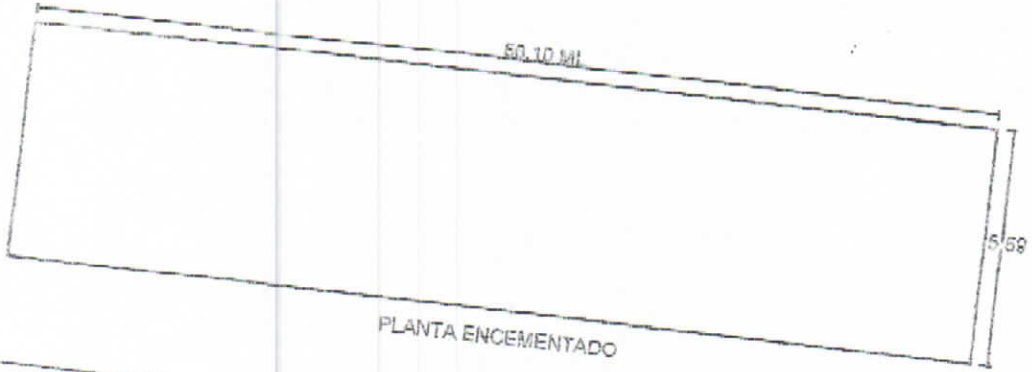
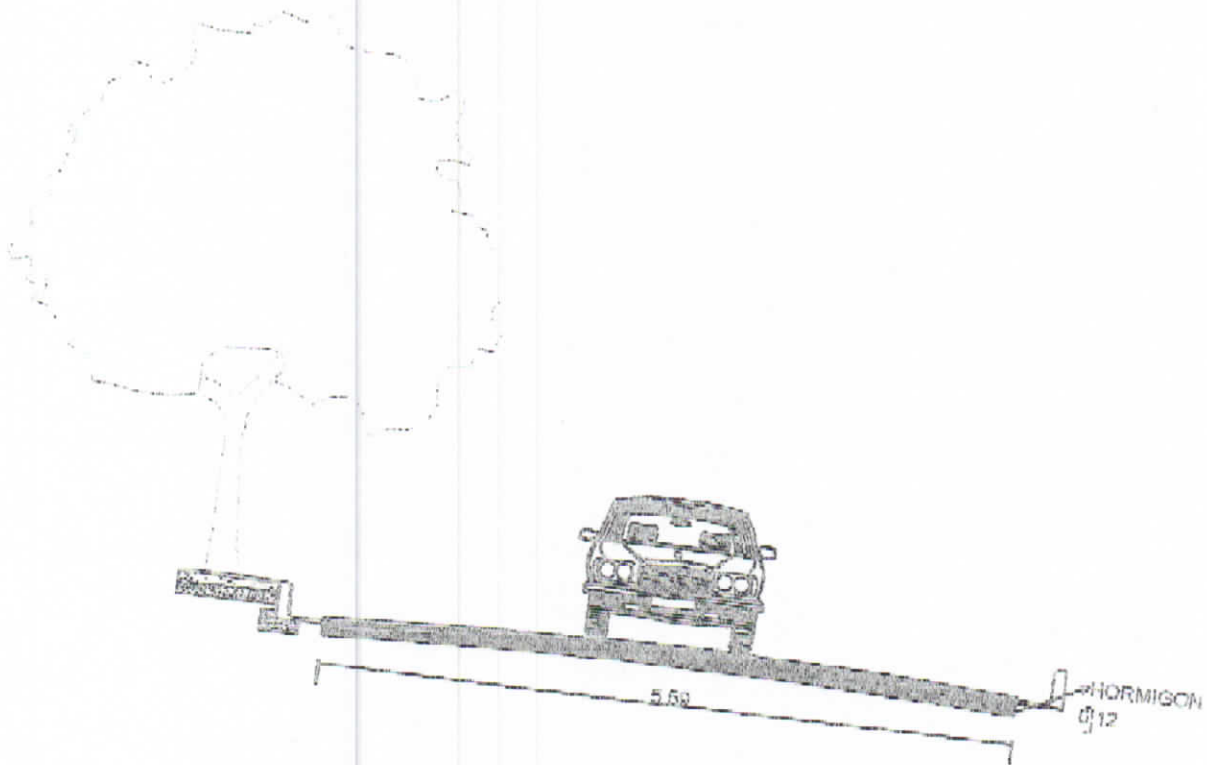

PLANTA ENCEMENTADO

NOTA: MALLA 20X20 E=12 CM

● ENCAJONAMIENTO CERRADO

GREGORIO LUPERON

LONGITUD 114 ML

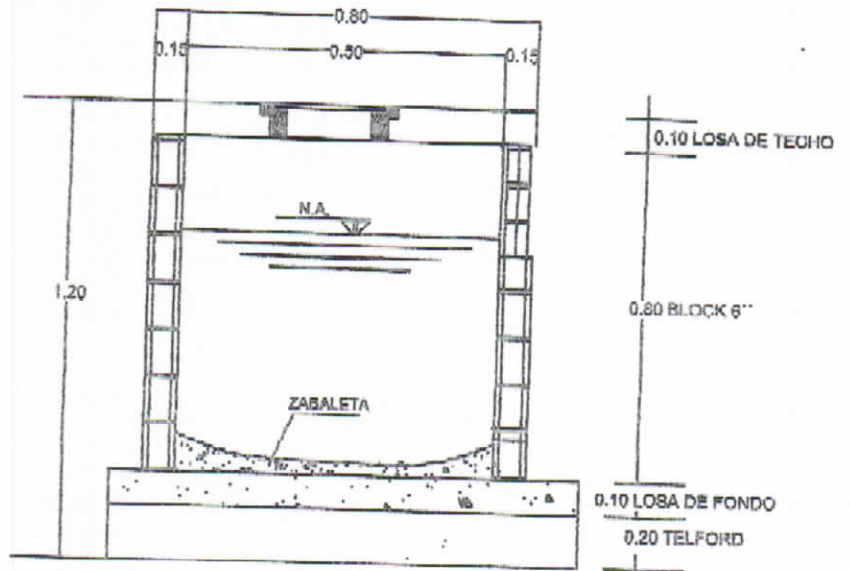
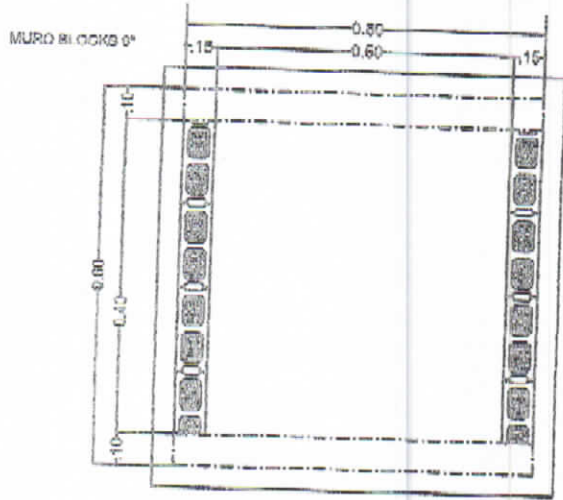

COLOCACION DE ALCANTARILLA EN EL
SECTOR GUZMAN DOS

DETALLE DE ZANJA
PARA TUBERIAS

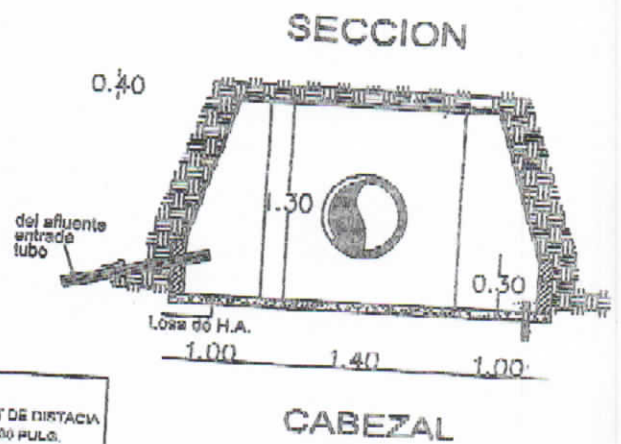
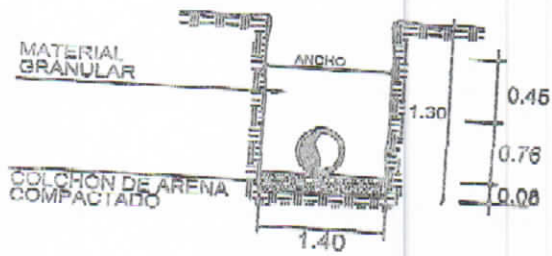

NOTA:
8 REGISTRO A 30 MT DE DISTANCIA
ALCANTARILLAS DE 30 PULG.
170 ML DE LONGITUD

NOTA AFIRMADO CALLE:
400.00 M³ DE MATERIAL GRANZOTE-TOSCA

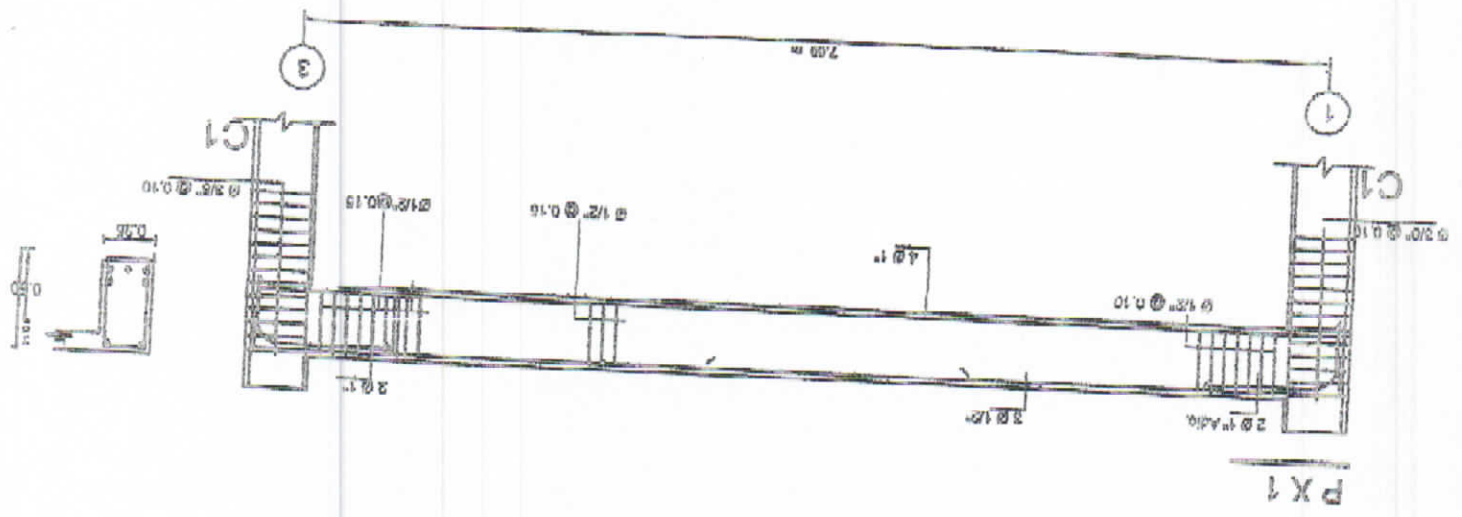

DETALLE DE COLUMNA

C-1

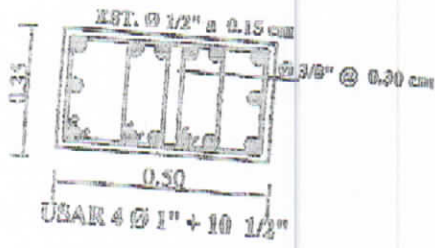

DETALLE Zap Col Z-1

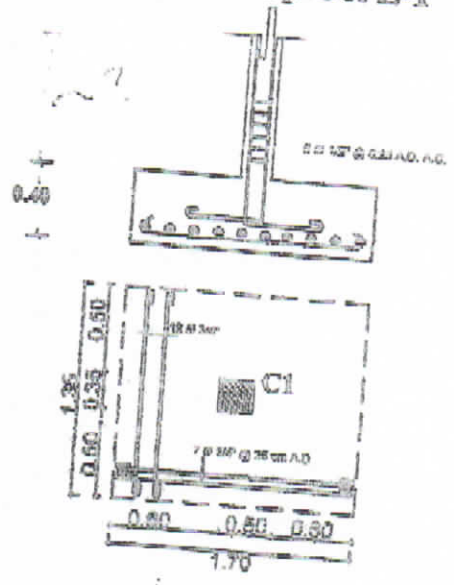

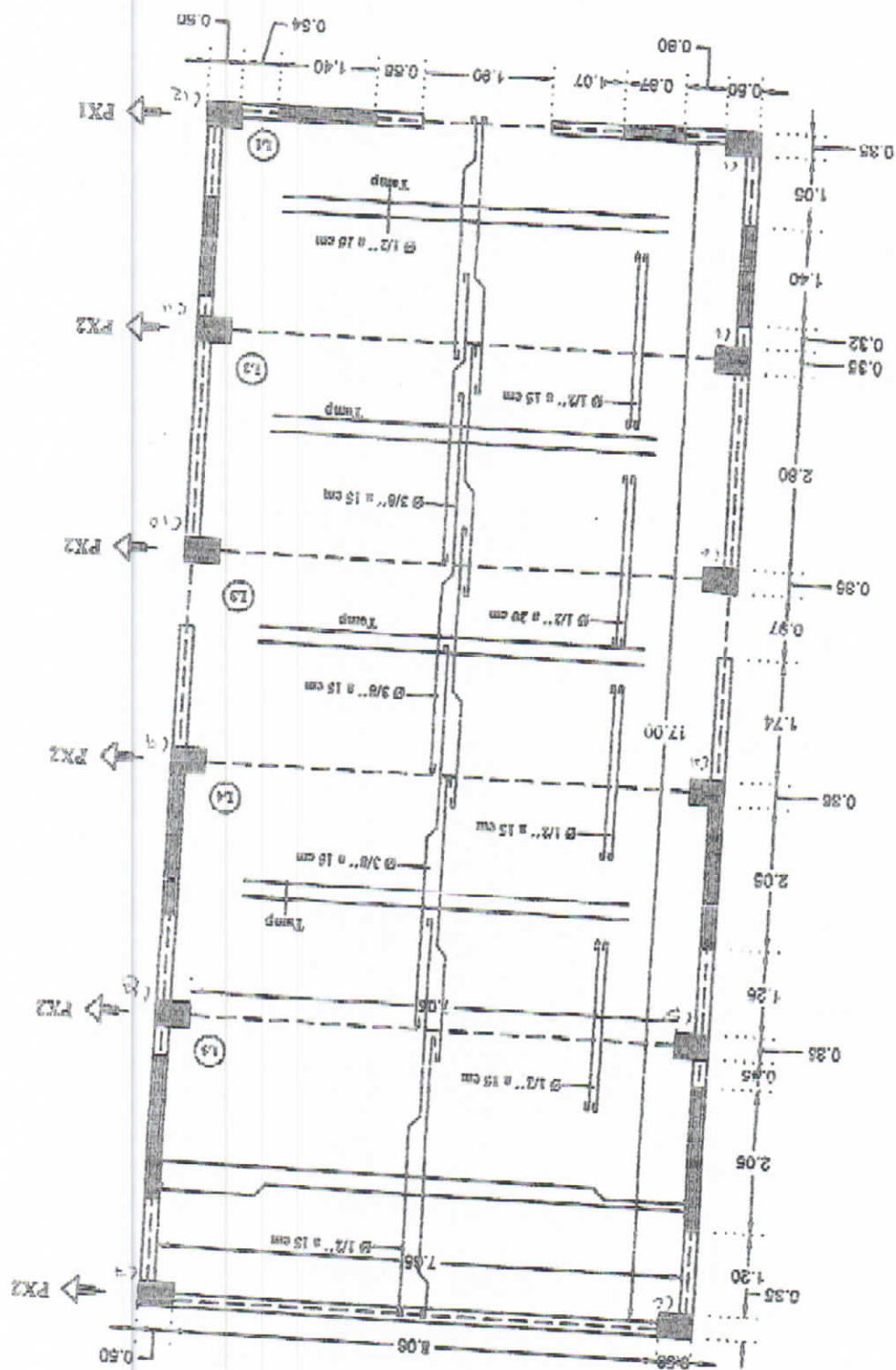

BADEN
ALMENDRO - LA YAGUIZA

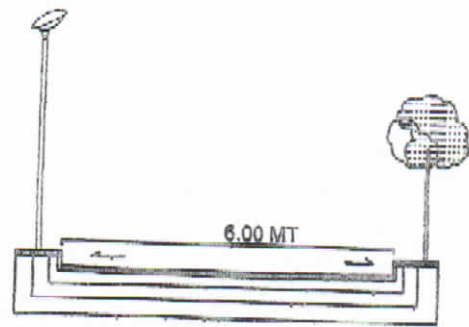
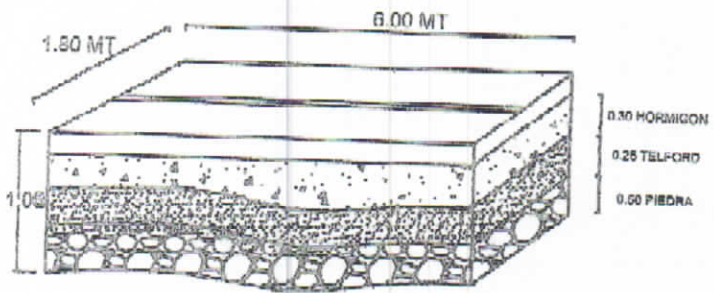

ENCEMENTADO EN LA COMUNIDAD LA YAGUIZA

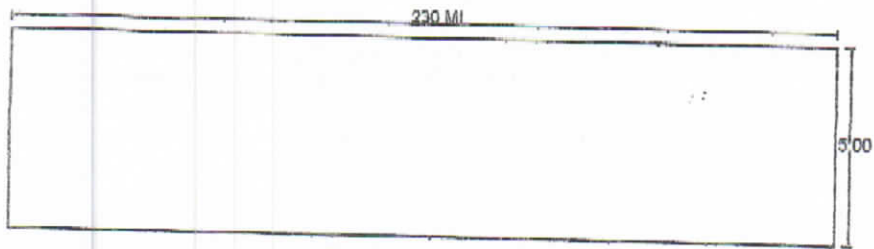
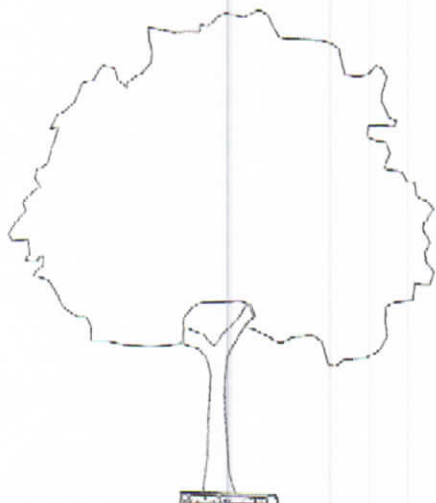

PLANTA ENCEMENTADO

NOTA: MALLA 20X20 E=12 CM

ENCEMENTADO EN LA COMUNIDAD LOS BASILIOS

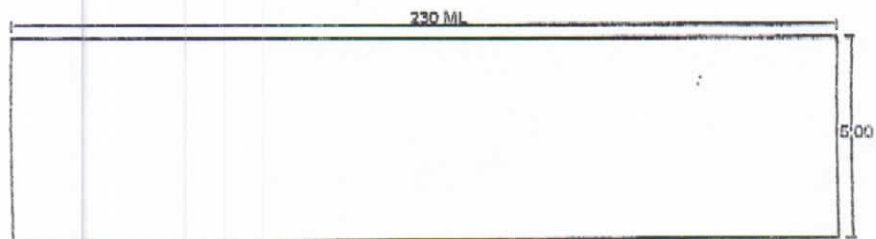
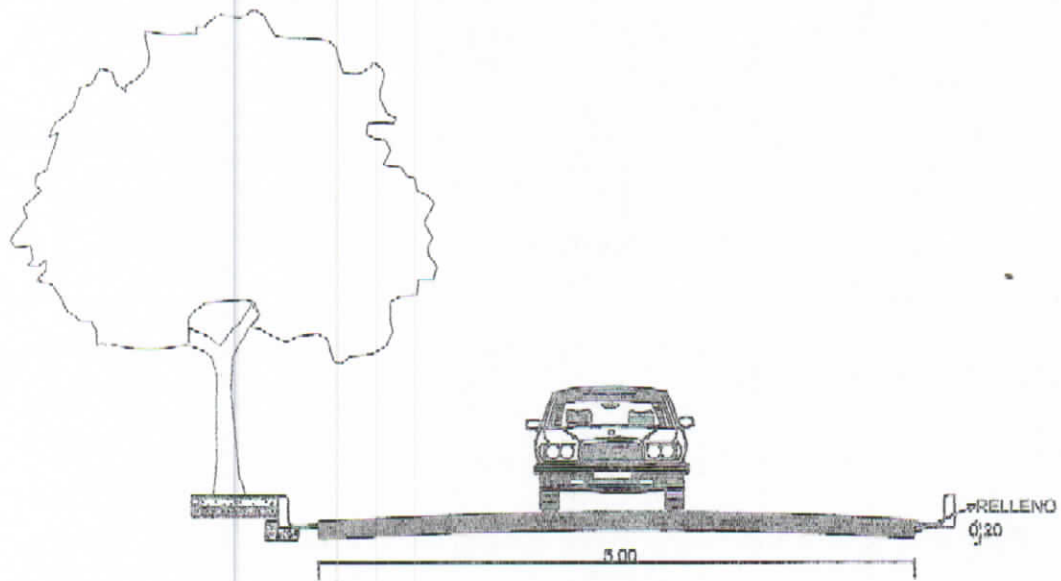

PLANTA ENCEMENTADO

NOTA: MALLA 20X20 E=12 CM